



100% PURE SINE WAVE SOLAR INVERTER

USER'S MANUAL SOLAR INVERTER

PV3300 TLV(1KW~6KW)

Please download the software “SolarPowerMonitor2.2.81”.

Download link: <https://bit.ly/2PpyLg6>



Scan QR code for manual



Appliances



PC



TV



Air-conditioning



Fridge



Washing machine

TABLE OF CONTENTS

General Precautions.....	1
Personnel Precautions.....	1
Introduction.....	2
Features.....	2
LCD Panel Description.....	2
Back panel printing description.....	2
Installation.....	3
Unpacking and inspection.....	3
Mounting the Unit.....	3
DC Wiring Suggestion.....	4
AC Input/Output Connection.....	5
PV Module Selection.....	6
Operation.....	6
Operation key instructions.....	6
Setting key instructions.....	7
LCD display.....	8
Operating mode description.....	9
AGS function.....	9
AGS function information.....	9
Dry contact operating voltage.....	10
Inverter Fan.....	10
BTS function.....	11
BTS function description.....	11
Communication.....	11
Upper Computer Monitoring directions.....	11
The operation steps are as follows.....	11
Monitor software function operation.....	12
Specifications.....	12
Inverter Mode Specification.....	12
AC Mode Specification.....	13
Charge Mode Specifications.....	13
LCD display instruction	15
MPPT controller warning	16



WARNING!

This manual contains important instructions for all Inverter/Charger models that shall be followed during installation and maintenance of the inverter.

The following cases are not within the scope of warranty

1. Out of warranty.
2. Series number was changed or lost.
3. Battery capacity was declined or external damaged.
4. Inverter was damaged caused of transport shift, remissness, ect external factor
5. Inverter was damaged caused of irresistible natural disasters.
6. Not in accordance with the electrical power supply conditions or operate environment caused damage.

General Precautions

Before using it, read all instructions and markings:

- (1) inverter (2) battery (3) user manual

CAUTION:

1. To reduce risk of injury, charge only lead-acid rechargeable batteries. If customer use flooded batteries, batteries must be maintained regularly. Other battery types may cause damage and injury.
2. Do not expose it to rain, snow or any type liquids. Inverters are designed for indoor use.
3. Do not disassemble it. Take it to qualified service center when service or repair is needed.
4. To prevent the risk of electric shock, disconnect all wiring before attempting any maintenance or cleaning. Only turning off the unit will not reduce the risk.

WARNING:

1. Provide ventilation from the battery compartment to outdoors. The battery enclosure should be designed to prevent accumulation and concentration of hydrogen gas at the top of the compartment.
2. NEVER charge a frozen battery and connect such 12V/24V/48V batteries to inverter.
3. Input/output AC wiring mustn't be less than 12AWG and not rated for 75 °C or higher. Battery cable mustn't be rated for 75°C or higher and should be no less than 4AWG /6AWG gauge.
4. Pay special attention when working with metal tools around batteries. Batteries short-circuiting could cause an explosion.
5. Read the battery installation and maintenance instructions carefully before operating.

Personnel Precautions

1. Better to prepare plenty of fresh water and soap nearby in case battery acid contacts skin, clothing or eyes.
2. Avoid touching eyes while working near batteries.
3. NEVER smoke or allow a spark or flame near batteries.
4. Remove personal metal items such as rings, bracelets, necklaces, and watches when working with batteries. Batteries may provide heavy short-circuit current, which would be enough to make metal melt and causes severe burn.
5. If a remote or automatic generator start system is used, disable the automatic starting circuit or disconnect the generator to prevent accident during servicing

Introduction

This inverter is applicable to different markets demands, it matches different voltage AC 120V/240V, also can set output voltage, frequency, charging voltage, charging current, it's available to work in split phase power environment.

Features:

- Pure sine wave output
- Friendly user interface
- 3 Steps charging
- MFD (multi-function display)
- Overload and short-circuit protection
- Set charging voltage/charging current.
- Battery low voltage shutdown point can be set to 10/10.5/11/11.5V
- Power-save mode
- Set utility priority/ Battery priority
- Set utility input wide/narrow range
- Inverter voltage can be set to 100/110/120
- Inverter frequency can be set to 50/60Hz
- Set utility charging on/off switch
- 80A MPPT charger

LCD Panel Description

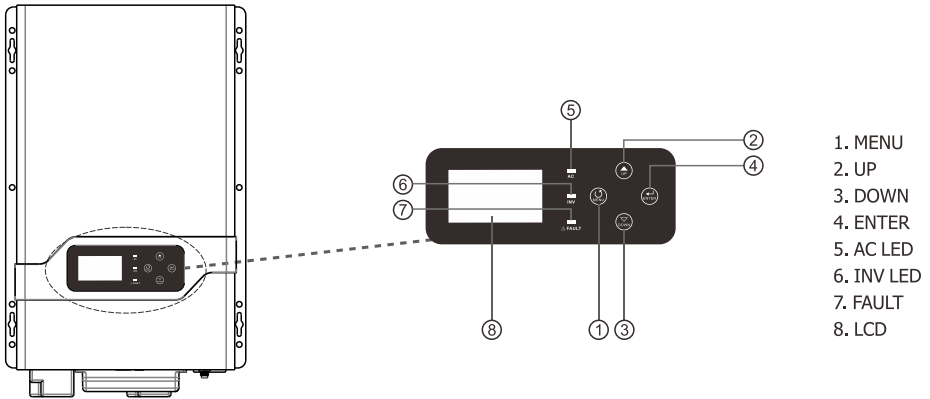

Back panel printing description:

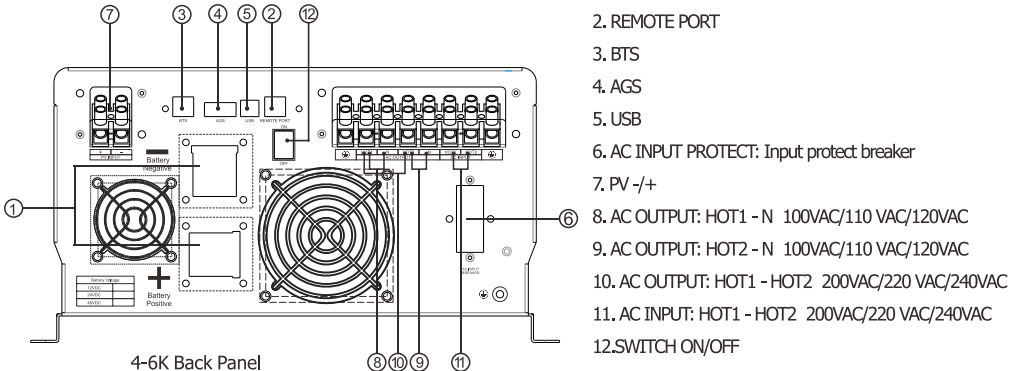

Installation

Unpacking and inspection

Before installation, please inspect whole unit. Be sure that nothing inside the package is damaged. You should have received the following items inside of package.

User manual X 1

Software CD X 1(Optional)

Communication cable X 1

Battery cables (RED/BLACK) X 2(Optional)

Mounting the Unit

Consider the following points before selecting where to install:

- Do not mount the inverter on flammable construction materials.
- Mount on a solid surface.
- Install this inverter at eye level in order to read the LCD display clearly.
- For proper air circulation to dissipate heat, require a clearance about 50 cm to the side and 80 cm above and below the unit.
- The ambient temperature should be between 0°C and 40°C to ensure optimal operation.
- The recommended installation position is to be adhered to the wall vertically.
- Be sure to keep other objects and surfaces as shown in the diagram to guarantee sufficient heat dissipation and to have enough space for removing wires.



SUITABLE FOR MOUNTING ON CONCRETE OR OTHER NON-COMBUSTIBLE SURFACE ONLY.

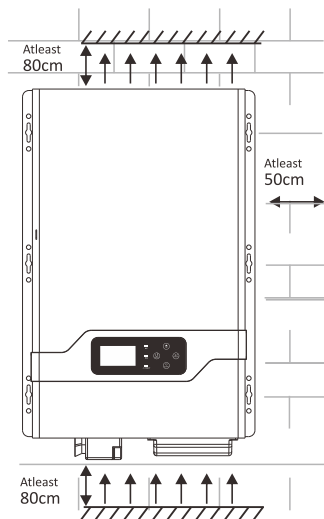

Install the unit by screwing four screws

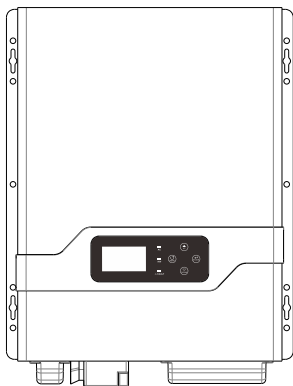

1-3K Inverter Case

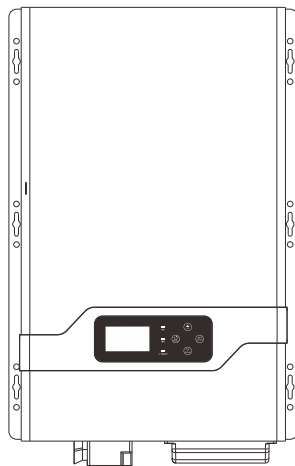

4-6K Inverter Case

DC Wiring Suggestion

It is suggested to keep battery bank as close as possible to inverter, battery cable length 1m is suggested. Please find following minimum wire size. If DC cable longer than 1 m, please use thicker battery cables to bear power current going through.

Model	Battery Voltage	Wire Type	Model	Battery Voltage Type	Wire Type
1KW	12VDC	6AWG	3KW	24VDC	3AWG
	24VDC	6AWG		48VDC	6AWG
1.5KW	12VDC	4AWG	4KW	24VDC	2AWG
	24VDC	6AWG		48VDC	4AWG
2KW	12VDC	2AWG	5KW	48VDC	3AWG
	24VDC	4AWG	6KW	48VDC	3AWG

Please connect cable size thicker enough, or connect several combined thin cables together to be same strong. Battery bank should be kept close to inverter; The shorter and thicker cables, the better the system performance.

Please follow battery connection steps below:

Assemble battery ring terminal.

Connect all battery packs as units requires.

Battery cable and terminal size suggestion:

It's suggested to connect at least 100Ah capacity battery pack for 1KW-3KW models, at least 200Ah for 4KW-6KW models.

NOTE: Please only use sealed lead acid battery or sealed GEL/AGM lead-acid battery.

Insert the ring terminal of battery cable into inverter to battery connector, make sure the bolts are tightened with torque of 2-3Nm. Pay special attention to battery back and inverter are connected rightly, also ring terminals are tightly screwed to the battery terminals.

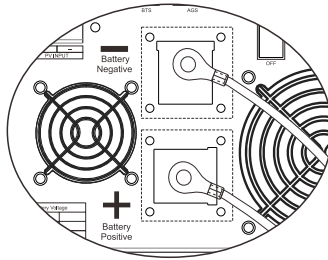

	<p>WARNING: Shock Hazard Installation must be performed with care due to high battery voltage in series.</p>
	<p>CAUTION!! Do not place anything between the flat part of the inverter terminal and the ring terminal. Otherwise, overheating may occur. CAUTION!!! Do not apply antioxidant substance on the terminals before terminals are connected tightly. CAUTION!!! Before making the final DC connection or closing DC breaker/ disconnecter, be sure positive(+) must be connected to positive(+) and negative(-) must be connected to negative(-).</p>

AC Input/Output Connection

CAUTION!! Before connecting to AC input power source, please install a separate AC breaker between inverter and AC input power source. This will ensure inverter can be disconnected safely during maintenance and fully protected from over current of AC input.

Suggestion AC breaker: 50A for 1KW-3KW, 80A for 4KW-6KW.

CAUTION!! Please don't connect the output wiring to "Grid" terminal or connect the grid wiring to the "Load" terminal.

WARNING! All wiring must be performed by a qualified personnel.

WARNING! It's very important to use appropriate cable for Grid connection for system safety and efficient operation. To reduce injury risk, please use the proper suggested cable size as below.

AC Wiring

We recommend using 10-16AWG wire to connect AC terminal block.

There are 3 different ways to connect AC wire to terminal block. All wirings are CE compliant, call our tech support if you are not sure about how to wire any part of your inverter.

Suggested cable requirement for AC wires

Model	Gauge	Torque Value
1-3KW	12-14AWG	1.2-1.6Nm
4-6KW	10-12AWG	1.4-1.6Nm

Please follow steps below to implement Load/Grid connection:

- Before Load/Grid connection, be sure to open DC protector first.
- Remove insulation sleeve 10mm for six conductors. And shorten phase L and neutral conductor N 3 mm.
- Insert grid wires according to polarities indicated on terminal block and tighten terminal screws. Be Sure to connect PE protective conductor(⊕)first.

AC INPUT Connection

- ⊕ → **Ground (yellow-green)**
- HOT1 (brown or black)**
- HOT2 (brown or black)**

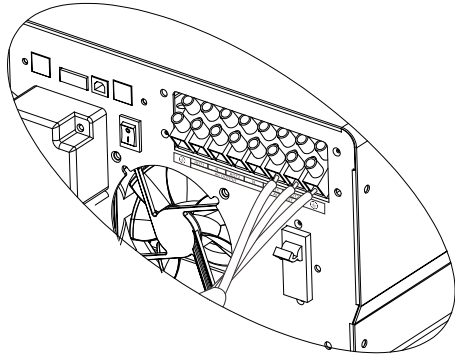

	WARNING: Be sure that AC power source is disconnected before hard-wire it to the unit.
--	--

- Then, insert Load wires according to polarities indicated on terminal block and tighten terminal screws. Be sure to connect PE protective conductor(⊕)first

AC OUTPUT Connection

- ⊕ → **Ground (yellow-green)**
- HOT1 → LINE (brown or black)**
- N → Neutral (blue or white)**
- HOT2 → LINE (brown or black)**

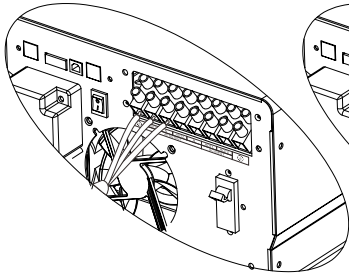

AC OUTPUT HOT1-N

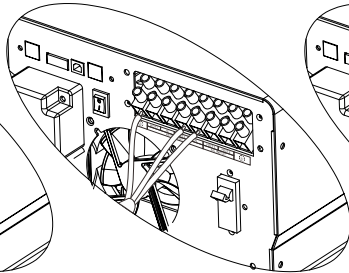

AC OUTPUT HOT2-N

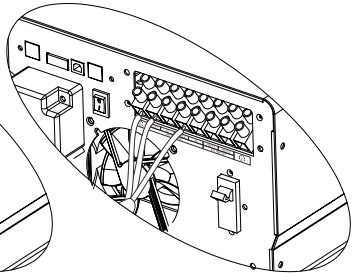

AC OUTPUT HOT1-HOT2

- Make sure the wires are securely connected

CAUTION: Appliances such as air conditioner are required at least 2-3 minutes to restart because it's required to have enough time to balance refrigerant gas inside of circuits. If a power shortage occurs and recovers in a short time, it will cause damage to your connected appliances. To prevent this kind of damage, please check manufacturer of air conditioner if it's equipped with time-delay function before installation. Otherwise, this inverter will be triggered overload fault and cut off output to protect your appliance but sometimes it still causes internal damage to the air conditioner.

PV Module Selection:

Please follow below steps to implement PV module connection:

1. Remove insulation sleeve 10 mm for positive and negative conductors
2. Check correct polarity of connection cable from PV modules and PV input connectors. Then, connect positive pole (+) of connection cable to positive pole (+) of PV input connector. Connect negative pole (-) of connection cable to negative pole (-) of PV input connector.
3. Make sure the wires are securely connected.

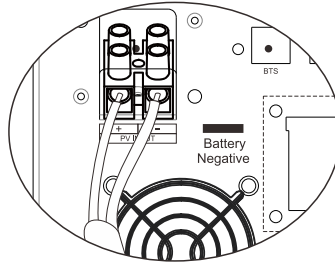
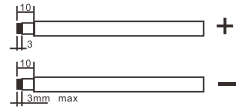

Operation

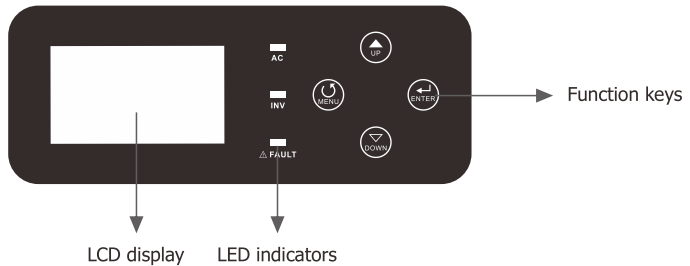

Operation key instructions:

- Switch button to control the machine On and off.
- There are four buttons: MENU, UP, DOWN, ENTER.
- Via UP and DOWN can check the various parameters display.
- Long press MENU to enter the setting menu page, MENU and ENTER turn over the menu page, UP and DOWN to set the parameters. After setting, long press ENTER 2s to exit, except the inverter frequency and inverter voltage parameters, The setting parameters are not saved to the EEPROM. The EEPROM is saved only when the parameters are normally set. (To ensure that the parameters can be successfully saved, so every time after setting the parameters need restart the machine).

Fault Mode

LED instruction

LED	LED state	information
LED AC(green)	Off	No AC input
	On	AC normal
	Blink	AC over range
LED Inv(yellow)	Off	
	On	Inverter mode
LED Fault(red)	Off	normal
	On	fault
	Blink	caution

BUZZER instruction

Buzzer state	information
Buzzer off	normal
Buzzer beep	caution
Buzzer on	fault

Setting key instructions:

MENU	Function key	Function description	
01	Battery/AC priority setting	Utility priority(default) [01] UT ₁	If choice UT ₁ , the inverter work in AC model until AC cut off or over the AC range.
		Battery priority [01] SBU	The inverter work in AC model if battery less 20set value. The inverter work in DC model if battery more than 21set value continue 1min.
02	Utility power range setting	vdE: Wide(default) [02] vdE	If set Wide, the AC range 140-270V.
		NRU: Narrow [02] N-U	If set NRU, the AC range 180-270V.
03	Inverter voltage setting	110V(default) [03] 110 _v	(100/110/120)
04	Inverter frequency setting	50HZ(default) [04] 50.0 _{Hz}	60HZ [04] 60.0 _{Hz}
13	AC charging setting	Rated current(default) [13] 40 _A	10A~Rated current. Regulation step 5A
17	Boost voltage setting	14.1V(default) [17] 14.1 _v	Range of adjustment 13.8-14.5V
18	Floating charging setting	13.5V(default) [18] 13.5 _v	Range of adjustment 13.5-14.5V
19	Battery low voltage shutdown point setting	10.5V(default) [19] 10.5 _v	Range of adjustment 10-11.5V
20	SBU Battery low voltage power point	11.5V(default) [20] 11.5 _v	Range of adjustment 10.5-12.0V If you choice SBU, when the battery voltage less than value, the inverter will work in AC model
21	SBU Battery high voltage inverter point	13.5V(default) [21] 13.5 _v	Range of adjustment 13V-14.0V If you choice SBU, when the battery voltage more than value continue 1min, the inverter will work in DC model.

23	LCD back light settings	LCD ON 	The LCD back light on.
		LCD OFF(default) 	Press any button to light up continue 1min.
24	Buzzer switch settings	Buzzer ON(default) 	Buzzer OFF
		SEN 	Save mode enable inverter is set to detect the load every 5/30 seconds
27	Save mode switch settings	Sdi(default) 	Save off The save model disable.
		5s(default) 	5s inverter is set to detect the load every 5 seconds. 30s inverter is set to detect the load every 30 seconds.
28	Search time settings in Save mode	AC charging on(default) 	AC charging off
29	AC charging switch settings	14.2V(default) 	
30	MPPT controller Absorption voltage set	13.5V(default) 	
31	MPPT controller float voltage set		
UP	Page up key		
DOWN	Page down key		
ENTER	Confirm the exit key		

LCD display:

Selectable information	LCD display	
Software material No. / Version No.		
Battery voltage / Rated power	BATT	LOAD KW
Output Voltage / Output Frequency	v	OUTPUT Hz
Input Voltage / Input Frequency	v INPUT	Hz

Battery Voltage / Current	BATT 26.0 V	4 A
Load Power / Percentage	30 W	LOAD 1 %
Battery / Inverter Temperature	BATT TEMP 0 °C	INV 48 °C
Solar charge current/power	PV 30.0 A	800 W

Operating mode description

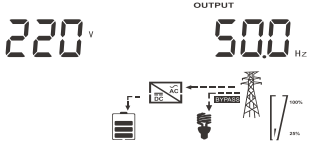
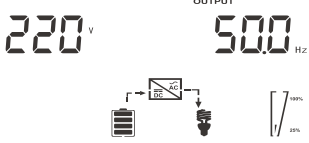
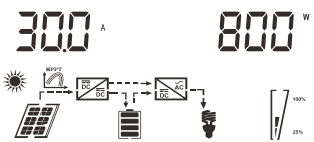
Operation mode	Description	LCD display
Fault mode	If any fault has happened, the machine will enter to the mode. And fault code is displayed on the LCD.	
Line mode	Input power will provide energy to load directly. And it will charge the battery at the same time. If voltage of input power is outside of section, the machine will switch to battery mode.	
Battery mode	The unit will get energy from battery and provide to load.	
PV mode	The unit will get energy from solar and provide to load.	

AGS function

AGS function information

The AGS function is that the inverter will start the generator automatically via the dry contact when the battery is low voltage.

Note:

The generator must have dry contact function.

If you connect AC grid and Generator to Inverter input at the same time, the interlock device should be installed between generator output and inverter input. (To ensure the utility and generator will not provide power to inverter at the same time. It doesn't need to be installed if only connect generator).

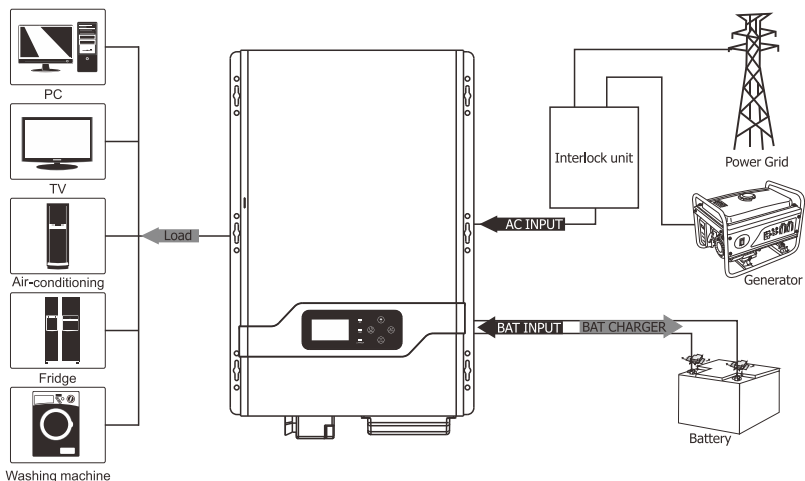

Dry contact operating voltage

Set Low Shutdown Voltage	Operation Voltage	Restoring Voltage
10V/20V/40V	DC<10.5V/21V/42V	DC>13.5V/27V/54V
10.5V/21V/42V	DC<11V/22V/44V	DC>13.5V/27V/54V
11V/22V/44V	DC<11.5V/23V/46V	DC>13.5V/27V/54V
11.5V/23V/46V	DC<12V/24V/48V	DC>13.5V/27V/54V

That is when the dry contact is engaged at DC<set low shutdown point + 0.5V (battery low voltage warning point), at DC>13.5V. (12V model)

Inverter Fan

DC fan:only full speed check the signal	Start inverter	Fullspeed	After start inverter	Half speed
	Inverter T>50°C	Fullspeed	Inverter T<40°C	Half speed
	Load>50%	Fullspeed	Load<45%	Half speed
4-6KW AC fan:dont check the signal	Fullspeed			

Unit charge function:

Inverter & MPPT controller:solar energy not enough,inverter will charge remain current.

Inverter set charge current	Solar charge current	Inverter charge current
example:40A	0A	40A
	10A	30A
	>40A	0A

UTI/SBU function:

Set	Convert condition	Convert stage specification
UTI	until AC cut off or over the AC range	AC model to DC model
SBU	DC<20 set page parameter	DC model to AC model
	PV>15V/ _(12V) & DC>21set page parameter and 1min	AC model to DC model

BTS function

BTS function description:

- The inverter collects the battery temperature through the BTS port, based on 25°C with each rise of 1°C, the charging voltage drops by 18mV/1 at the set charging voltage (up to 60°C).
BTS down charge voltage is based on drops of boost voltage and float voltage.
- Using an optional battery temperature cable to connect the inverter and battery.

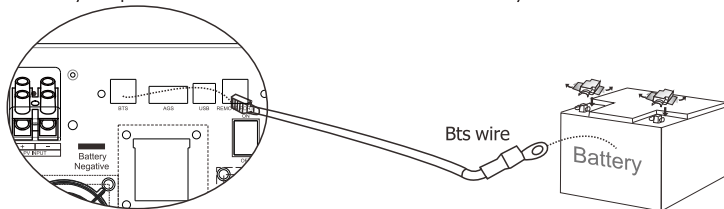

Communication

Upper Computer Monitoring directions:

Monitoring software: This software supports the communication function for various models of our company. The software will searching the COM Port and inverter model automatically.

The operation steps are as follows:

Connect the Inverter and Computer.

connect the inverter with a communication cable to the computer with usb communication port.

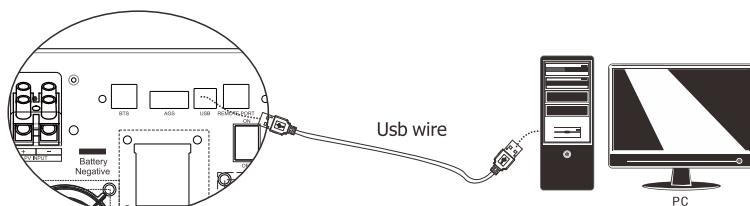

Install the software: Solar Power Monitor

1. Put the CD in the computer CD driver, install the software Solar Power Monitor (Proper install following the steps)
2. Choose Solar Power Monitor. exe and install.
3. Open the PowerMonitor, turn on the machine.
4. The SolarPowerMonitor will auto scan communication port.

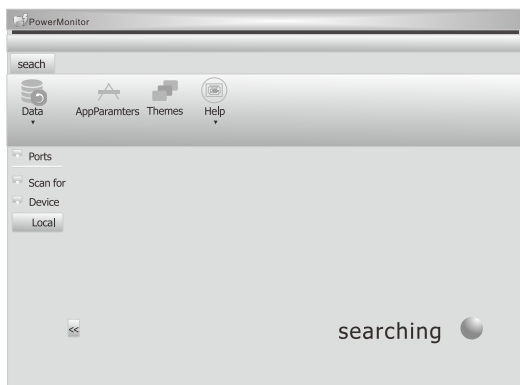

5.Wait for a moment, Power Monitor will work normally.

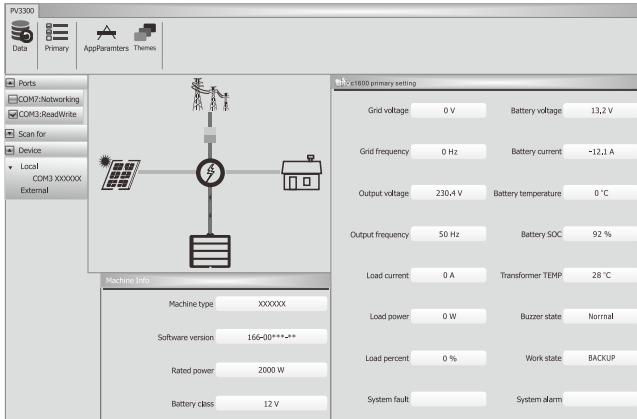

Monitor software function operation

Specific function Operations of the monitoring software, please referring to the HELP docs after the connection is successful.

Specifications

Inverter Mode Specification

Model	1012	1024	1512	1524	2012	2024	3024	3048	4024	4048	5048	6048
Rated power(W)	1KW		1.5KW		2KW		3KW		4KW		6KW	
Power Factor	1											
Wave form	Pure sine wave											
Output voltage RMS	100V/110V/120VAC(200V/220V/240VAC)±10%											
Output frequency	50HZ or 60HZ (±0.3HZ)											
Inverter efficiency(peak)	>80%											
Overload	100%<Load<110% (alarm 5min then stop output and fault code 07) 110%<Load<125% (alarm 60s then stop output and fault code 07) Load>125% (alarm 10s then stop output and fault code 07)											
Surge rating	3000VA	4500VA	6000VA	9000VA	12000VA	15000VA	15000VA					
Capable of starting electric motor		1P	1.5P	1.5P	2P	3P						
Battery voltage	12VDC/24VDC				24VDC/48VDC				48VDC			
Minimum start voltage	11VDC/22VDC/44VDC											
Low battery cut off	(low voltage fault code04) (10/10.5/11V/11.5V) for 12V model (20/21/22/23V) for 24V model (40/42/44/46V) for 48v model											
Low battery alarm	Add 0.5V/battery: (low battery alarm one second one time) (10/10.5/11V/11.5V) +0.5Vdc for 12V model (20/21/22/23V) +1Vdc for 24v model (40/42/44/46V) +2Vdc for 48v model											
High voltage alarm	Add +1V/battery: (high voltage one second one time/after 30s fault 03) (13.8-14.5V) + 1V for 12V model (27.6-29V) + 2V for 24v model (55.2-58) + 4V for 48v model											
Save mode	Load≤40W(110V)/80W(220V)											

AC Mode Specification

AC parameter

Input waveform	Pure sine wave
Nominal input voltage	200Vac / 220Vac / 240Vac
Max input voltage	270Vac MAX
Input frequency	50HZ/60HZ (auto sensing)
Output waveform	Same as input waveform
Overload protection	Breaker + software protection
Output short circuit	Breaker+ software protection
Efficiency(AC mode)	>95%® load, full battery)
Transfer time AC TO DC	15ms(Typical)
Transfer time DC TO AC	15ms(Typical)

AC input voltage range: (±5V)

model	range	Low cutoff	Low recover	High cutoff	High recover
220V	narrow	AC<180V	AC>190V	AC>270V	AC<265V
		F<40HZ	F>45HZ	F>70HZ	F<65HZ
	wide	AC<140V	AC>150V	AC>270V	AC<265V
		F<40HZ	F>45HZ	F>70HZ	F<65HZ

Charge Mode Specifications

Max charge current: (±5A)

model	1K	1.5K	2K	3K	4K	5K	6K
12V	30A	45A	60A				
24V	20A	25A	30A	40A	60A		
48V				20A	30A	35A	40A
Min charge current 10A. change by every 5A.							

Charge mode AC range:

Setting	Low voltage	Charge mode	recover	Charge mode
220V AC wide range	AC>265V	Stop charge	AC<260V	Charge recover
	AC<155V	Stop charge	AC>160V	Charge recover
	40<F<70HZ charge			

Charge mode:

Charge current adjustable	Charge curreent adjustable: 10A~max (adjust by every 5A)
Battery voltage	10-14.5Vdc/20-29Vdc/40-58Vdc
Short circuit protection	breaker
Over charge protection	Bat V≥charge voltage+1V/battery,1s 1 time for 30s then alarm 03
rule	Boost CC → Boost CV → Boost FV

<p>Charge Stage Transition Definition</p>	<ul style="list-style-type: none"> ◆ Boost CC Stage: If A/C input is applied, the charger will run at full current in CC mode until the charger reaches the boost voltage. ◆ Boost CV Stage: the charger will keep the boost voltage in Boost CV mode until the charge current less 6A continue 1minute or keep the boost voltage time more than 2hours . Then drop the voltage down to the float voltage. ◆ Float Stage: In float mode, the voltage will stay at the float voltage. ◆ If the A/C is reconnected , the charger will reset the cycle above.
	<p>charge cure</p>





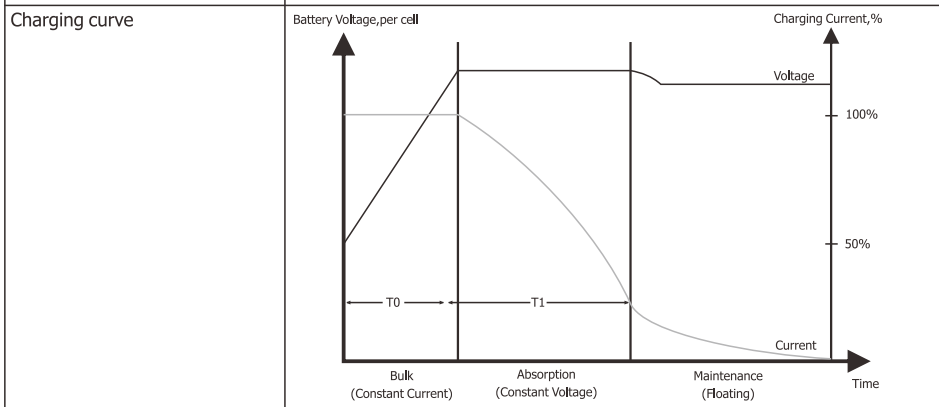



Solar charger(MPPT controller) electrical specification

Type	MPPT-80A			
Nominal system voltage	12V/24/48V(auto detection);			
Maximum charge current	80A±4A			
Battery voltage	12V	24V	36V	48V
Maximum solar input voltage	100±2V	145±2V		
PV array MPPT voltage range	15-95V	30-130V	45-130V	60-130V
Maximum input power	1250W	2500W	3750W	5000W
Charging stages	Bulk,absorption,float			
Over charging voltage	15.5V/30.0V/45.0V/60.0V			
Over charging comeback voltage	14.5V/29.5V/44.5V/59.0V			
Battery defect voltage	10.0V/17.0V/25.5V/34.0V			



LCD display instruction

When inverter alarm, even it back to recovery mode. We must restart inverter to clear fault.

Fault code	Fault	Fault instruction	What to do
	Fan fault	Fan stop run	Check the fan.
	Over temperature	BTS over temperature: $T_{battery} > 65^{\circ}\text{C}$ 1s 1 time for 1min then fault alarm 02; $T_{battery} < 60^{\circ}\text{C}$ recovery Inverter over temperature: $T_{inv} > 90^{\circ}\text{C}$ 1s 1time for 1min then fault alarm 02; $T_{inv} < 85^{\circ}\text{C}$ recovery	Power off and waiting for minute
	DC voltage too high	Battery over voltage: $\text{DC} > V_{(\text{charge voltage} + 1\text{V})/12\text{V}}$ alarm for 30s then fault code 03 Over voltage recovery: $\text{DC} < V_{(\text{charge voltage} + 1\text{V}) - 0.2\text{V}/12\text{V}}$	Check the battery specifications
	DC voltage too low	Low voltage alarm: $\text{DC} < V_{(\text{cutoff} + 0.5\text{V})/12\text{V}}$ Alarm recovery: $\text{DC} > V_{(\text{cutoff} + 0.5) + 0.2/12\text{V}}$ Low voltage fault: $\text{DC} < V_{\text{cutoff}}$ fault code 04	Check the battery specifications
	Output short circuit in DC model	Output short circuit: short circuit test fault 05	Remove your load and restart
	Output over voltage	Output over voltage: $V_{\text{output}} > 135\text{V}/270\text{V}$ 500ms fault 06	Return to repair center
	Output over load	overload: $100\% < \text{Load} < 110\%$ alarm per every second (5min later inverter cutoff output and fault 07) $110\% < \text{Load} < 125\%$ alarm per every second (60s later inverter cutoff output and fault 07) $\text{Load} > 125\%$ alarm per every second (10s later cut off output and fault 07)	Decrease your load
	Output over current	Inverter Output over current: 1-3K: $I_{\text{rms}} > 40\text{A}$. 4-6K: $I_{\text{rms}} > 80\text{A}$ 200ms fault 51	Check if wiring is connected well and remove abnormal load.
	Output low voltage in DC model	Output low voltage: $V_{\text{output}} < 85\text{V}/170\text{V}$ 500ms fault 58	Decrease your load

MPPT controller warning:

Warn code	Warn information	Warn information specification	What to do
[E0]▲	Hard ware protection		Return to repair center
[E1]▲	Over current		
[E2]▲	Current sensor error		
[E3]▲	MPPT controller over temperature		Stop PV charge soon
[E4]▲	PV voltage too high		Check PV
[E5]▲	PV voltage too low		
[E6]▲	Battery voltage too high		Check battery
[E7]▲	Battery voltage too low		
[E8]▲	Current is uncontrollable		Return to repair center
[E9]▲	Parameter error		
[F1]▲	MPPT controller fan		Check MPPT fan

**MUST**[®]

GUARANTEE CERTIFICATE

Serial No.: _____

Customer's Name				Contact Person	
Address				Telephone No.	
Product/Model:		Post Code		Fax No.	
Date of purchase			Expire Date		
Dealer Signature			Customer Signature		

**MUST**[®]

GUARANTEE CERTIFICATE

Serial No.: _____

Customer's Name				Contact Person	
Address				Telephone No.	
Product/Model:		Post Code		Fax No.	
Date of purchase			Expire Date		
Dealer Signature			Customer Signature		