



100% PURE SINE WAVE SOLAR INVERTER

# USER'S MANUAL SOLAR INVERTER

PV3000 (1KW~6KW)

Please download the software “SolarPowerMonitor2.2.81”.

Download link:<https://bit.ly/2PyyLg6>



## Appliances



PC



TV



Air-  
conditioning



Fridge



Washing  
machine



## TABLE OF CONTENTS

General Precautions.....	1
Personnel Precautions.....	1
Introduction.....	2
Features.....	2
LCD Panel Description.....	2
AC terminal panel printing description.....	3
Installation.....	3
Unpacking and inspection.....	3
Preparation.....	3
Mounting the Unit.....	4
DC Wiring Suggestion.....	4
AC Input/Output Connection.....	5
PV Connection.....	6
Operation.....	7
Operation key instructions.....	7
Setting key instructions.....	7
LCD display.....	10
AGS function.....	11
AGS function information.....	11
Dry contact operating voltage.....	11
BTS -CAN function.....	11
Communication.....	12
Connect inverter and battery.....	12
The operation steps are as follows.....	12
Specifications.....	13
Inverter Mode Specification.....	13
AC Mode Specification.....	14
Charge Mode Specifications.....	14
Solar charger(MPPT controller electrical) specification.....	14
Fault Mode.....	16
Trouble shooting .....	18
MPPT controller warning.....	19



## **WARNING!**

This manual contains important instructions for all Inverter/Charger models that shall be followed during installation and maintenance of the inverter.

The following cases are not within the scope of warranty

1. Out of warranty.
2. Series number was changed or lost.
3. Battery capacity was declined or external damaged.
4. Inverter was damaged caused of transport shift, remissness, ect external factor
5. Inverter was damaged caused of irresistible natural disasters.
6. Not in accordance with the electrical power supply conditions or operate environment caused damage.

### **General Precautions**

Before using it, read all instructions and markings:

(1) inverter (2) battery (3) user manual

### **CAUTION:**

1. To reduce risk of injury, charge only lead-acid rechargeable batteries. If customer use flooded batteries, batteries must be maintained regularly. Other battery types may cause damage and injury.
2. Do not expose it to rain, snow or any type liquids. Inverters are designed for indoor use.
3. Do not disassemble it. Take it to qualified service center when service or repair is needed.
4. To prevent the risk of electric shock, disconnect all wiring before attempting any maintenance or cleaning. Only turning off the unit will not reduce the risk.

### **WARNING:**

1. Provide ventilation from the battery compartment to outdoors. The battery enclosure should be designed to prevent accumulation and concentration of hydrogen gas at the top of the compartment.
2. NEVER charge a frozen battery and connect such 12V/24V/48V batteries to inverter.
3. Input/output AC wiring mustn't be less than 12AWG and not rated for 75 °C or higher. Battery cable mustn't be rated for 75°C or higher and should be no less than 4AWG /6AWG gauge.
4. Pay special attention when working with metal tools around batteries. Batteries short-circuiting could cause an explosion.
5. Read the battery installation and maintenance instructions carefully before operating.

### **Personnel Precautions**

1. Better to prepare plenty of fresh water and soap nearby in case battery acid contacts skin, clothing or eyes.
2. Avoid touching eyes while working near batteries.
3. NEVER smoke or allow a spark or flame near batteries.
4. Remove personal metal items such as rings, bracelets, necklaces, and watches when working with batteries. Batteries may provide heavy short-circuit current, which would be enough to make metal melt and causes severe burn.
5. If a remote or automatic generator start system is used, disable the automatic starting circuit or disconnect the generator to prevent accident during servicing

## Introduction

It is series is very economical pure sine wave inverter, AC charger inbuilt, from 20A to 60A; Solar/AC priority is configurable, when setting solar priority, solar will charge batteries as first priority, and AC can also charge batteries when solar charger current too lower, in this way system charge is optimized best. it enables inverter to operate with all kinds of home appliances.

## Features:

- Pure sine wave output
- Friendly user interface
- 3 Steps charging
- MFD (multi-function display)
- Overload and short-circuit protection
- Set charging voltage/charging current.
- Battery low voltage shutdown point can be set to 10/10.5/11/11.5/12V
- Power-save mode
- Set utility priority/ Battery priority
- Set utility input wide/narrow range
- Inverter voltage can be set to 120V:110V/115V/120V 220V:220V/230V/240V
- Inverter frequency can be set to 50/60Hz
- Set utility charging on/off switch
- 80A MPPT charger
- Acid or Lithium Select
- WIFI PORT
- BAT CAN Port

## LCD Panel Description

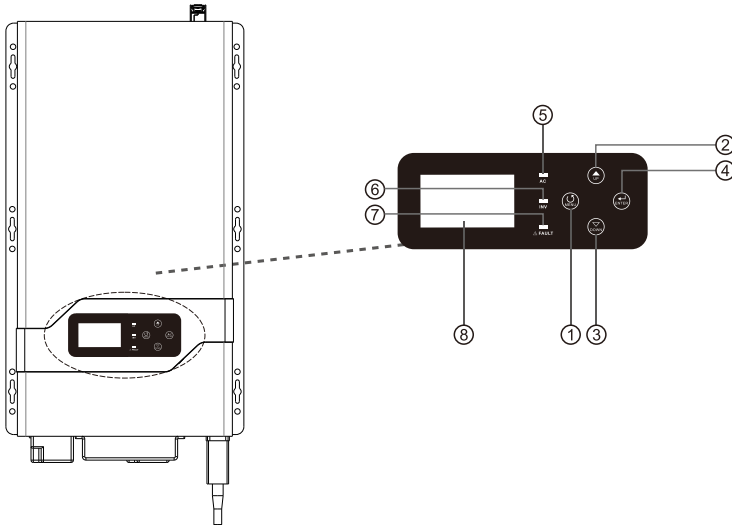

1. MENU
2. UP
3. DOWN
4. ENTER

5. AC LED
6. INV LED
7. FAULT
8. LCD

## AC terminal panel printing description.

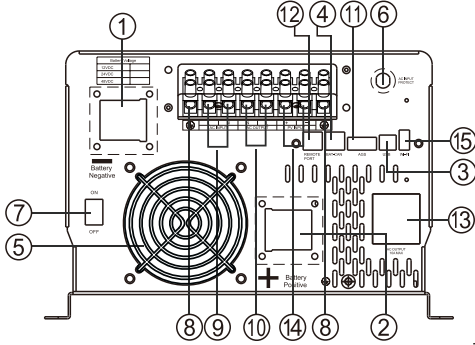

1-3KW

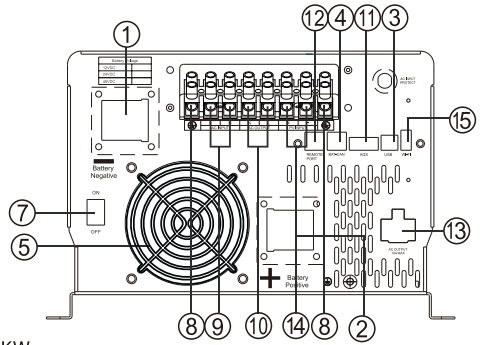

4-6KW

1. BAT -
2. BAT +
3. USB
4. BAT CAN port
5. FAN
6. AC input protect
7. Power on/off switch
8. GND

9. AC input
10. AC output
- 11 .AGS
12. Remote port
13. AC Output 10A(MAX)
14. PV input
- 15.WIFI
- 16.AC INPUT BREAKER

### Installation

#### Unpacking and inspection

Before installation, please inspect whole unit. Be sure that nothing inside the package is damaged. You should have received the following items inside of package.

- User manual X 1
- Communication cable X 1
- Battery cables (RED/BLACK) X 2 (Optional)

#### Preparation

Before connecting all wirings, please take off bottom cover by removing eight screws as shown below:

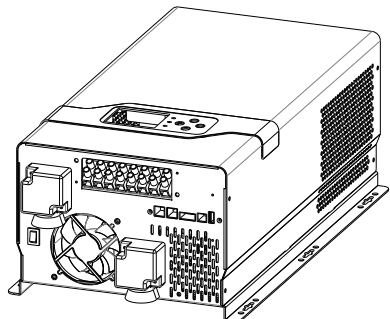
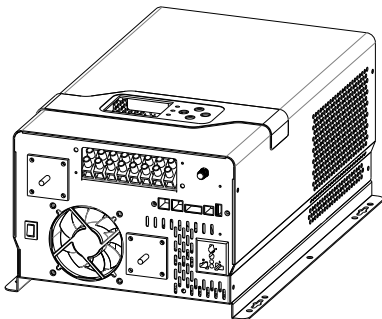

## Mounting the Unit

Consider the following points before selecting where to install:

- Do not mount the inverter on flammable construction materials.
- Mount on a solid surface.
- Install this inverter at eye level in order to read the LCD display clearly.
- For proper air circulation to dissipate heat, require a clearance about 50 cm to the side and 80 cm above and below the unit.
- The ambient temperature should be between 0°C and 40°C to ensure optimal operation.
- The recommended installation position is to be adhered to the wall vertically.
- Be sure to keep other objects and surfaces as shown in the diagram to guarantee sufficient heat dissipation and to have enough space for removing wires.

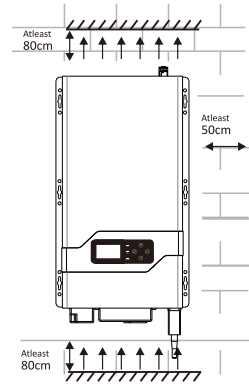

## DC Wiring Suggestion

It is suggested to keep battery bank as close as possible to inverter. battery cable length 1m is suggested.

Please find following minimum wire size. If DC cable longer than 1 m, please use thicker battery cables to bear power current going through.

Model	Battery Voltage Type	Wire Type
1KW	12VDC	4AWG
	24VDC	6AWG
1.5KW	12VDC	4AWG
	24VDC	6AWG
2KW	12VDC	2AWG
	24VDC	4AWG
3KW	12VDC	2AWG
	24VDC	3AWG
	48VDC	6AWG
4KW	24VDC	2AWG
	48VDC	4AWG
5KW	24VDC	2AWG
	48VDC	3AWG
6KW	24VDC	2AWG
	48VDC	3AWG

Please connect cable size thicker enough, or connect several combined thin cables together to be same strong. Battery bank should be kept close to inverter; The shorter and thicker cables, the better the system performance.

Please follow battery connection steps below:

Assemble battery ring terminal.

Connect all battery packs as units requires.

Battery cable and terminal size suggestion:

It's suggested to connect at least 100Ah capacity battery pack for 1KW-3KW models, at least 200Ah for 4KW-6KW models.

NOTE: Insert the ring terminal of battery cable into inverter to battery connector, make sure the bolts are tightened with torque of 2-3Nm. Pay special attention to battery back and inverter are connected rightly, also ring terminals are tightly screwed to the battery terminals.

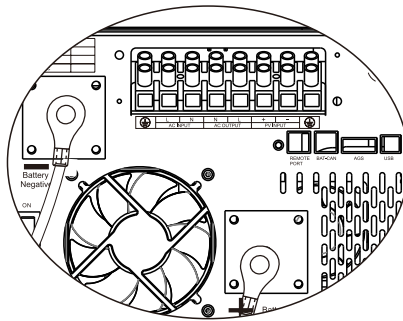

**WARNING: Shock Hazard**

Installation with special care is required due to high battery pack voltage.



**CAUTION!!** Do not place anything between the flat part of the inverter terminal and the ring terminal. Otherwise, overheating may occur.

**CAUTION!!** Do not apply antioxidant substance on the terminals before terminals are connected tightly.

**CAUTION!!** Before making the final DC connection or closing DC breaker/ dis-connector, be sure positive (+) must be connected to positive(+) and negative(-) must be connected to negative(-).

**AC Input/Output Connection**

**CAUTION!!** Before connecting to AC input power source, please install a separate AC breaker between inverter and AC input power source. This will ensure inverter can be disconnected safely during maintenance and fully protected from over current of AC input.

Suggestion AC breaker: 30A for 1KW-3KW, 40A for 4KW-6KW.

**CAUTION!!** Please don't connect the output wiring to "Grid" terminal or connect the grid wiring to the "Load" terminal.

**WARNING!** All wiring must be performed by a qualified personnel.

**WARNING!** It's very important to use appropriate cable for Grid connection for system safety and efficient operation . To reduce injury risk, please use the proper suggested cable size as below.

**AC Wiring**

We recommend using 10-5AWG wire to connect AC terminal block.

There are 3 different ways to connect AC wire to terminal block. All wirings are CE compliant, call our tech support if you are not sure about how to wire any part of your inverter.

<p>AC Wiring</p> <p>Input: Live line +Neutral + Ground</p> <p>Output : Live line +Neutral +Ground</p>	
---	--

**Suggested cable requirement for AC wires**

Model	Gauge	Torque Value
1-3KW	12AWG	1.2-1.6Nm
4-6KW	10AWG	1.4-1.6Nm



Please follow below steps to implement Load/Grid connection:

- Before making Load/Grid connection, be sure to open DC protector or disconnecter first.
- Remove insulation sleeve 10mm for six conductors. And shorten phase L and neutral conductor N 3mm.
- Insert grid wires according to polarities indicated on terminal block and tighten the terminal screws. Be Sure to connect PE protective conductor(⊕)first.

#### AC INPUT Connection

- ⊕ → **Ground (yellow-green)**
- L** → **LINE (brown or black)**
- N** → **Neutral (blue)**

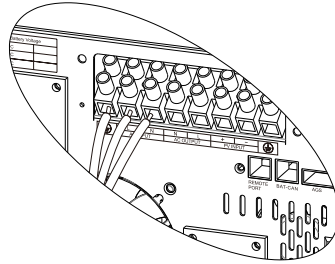

#### **WARNING:**

Be sure that AC power source is disconnected before hard-wire it to the unit.

- Then, insert Load wires according to polarities indicated on terminal block and tighten terminal screws. Be sure to connect PE protective conductor(⊕)first

#### AC OUTPUT Connection

- ⊕ → **Ground (yellow-green)**
- L** → **LINE (brown or black)**
- N** → **Neutral (blue)**

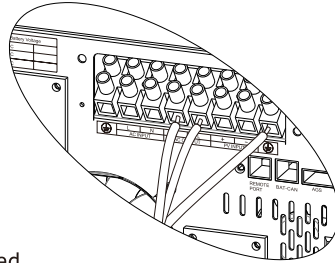

- Make sure the wires are securely connected.

**CAUTION:** Appliances such as air conditioner are required at least 2-3 minutes to restart because it's required to have enough time to balance refrigerant gas inside of circuits. If a power shortage occurs and recovers in a short time, it will cause damage to your connected appliances. To prevent this kind of damage, please check manufacturer of air conditioner if it's equipped with time-delay function before installation. Otherwise, this inverter will be triggered overload fault and cut off output to protect your appliance but sometimes it still causes internal damage to the air conditioner.

### PV Connection

Please follow below steps to implement PV module connection:

1. Remove insulation sleeve 10 mm for positive and negative conductors.
2. Check correct polarity of connection cable from PV module and PV input conductors. Then connect positive pole (+) of connection cable to positive pole (+) of PV input connector. Connect negative pole (-) of connection cable to negative (-) of PV input connector.

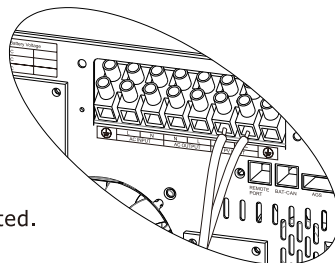
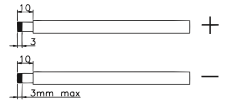

3. Make sure the wires are securely connected.

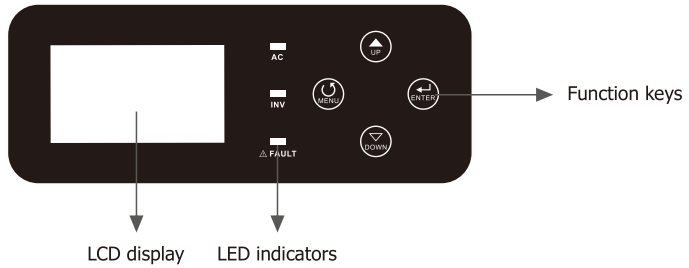

## Operation



### Operation key instructions:

- Switch button to control the machine On and off.
- There are four buttons: MENU, UP, DOWN, ENTER.
- Via UP and DOWN can check the various parameters display.
- Long press MENU to enter the setting menu page, MENU and ENTER turn over the menu page, UP and DOWN to set the parameters. After setting, long press ENTER 2s to exit, except the inverter frequency and inverter voltage parameters, The setting parameters are not saved to the EEPROM. The EEPROM is saved only when the parameters are normally set. (To ensure that the parameters can be successfully saved, so every time after setting the parameters need restart the machine).

### Setting key instructions:

MENU	Function key	Function description
01	Battery/AC priority setting	Utility priority(default)  If choice UT1, the inverter work in AC model until AC cut off or over the AC range.
		Battery priority  The inverter work in AC model if battery less 20set value. The inverter work in DC model if battery more than 21set value continue 1min.
		 Solar energy provides power to the loads as first priority. If battery voltage has been higher than the setting point in program 21 for 5 minutes, and the solar energy has been available for 5 minutes too, the inverter will turn to battery mode, solar and battery will provide power to the loads at the same time. When the battery voltage drops to the setting point in program 20, the inverter will turn to bypass mode, utility provides power to the load only, and the solar will charge the battery at the same time.

02	110 Utility power range setting	vdE: Wide(default) [02] vdE	If set Wide, the AC range 70-140V.
		NRU: Narrow [02] N-U	If set NRU, the AC range 90-140V.
	220 Utility power range setting	vdE: Wide(default) [02] vdE	If set Wide, the AC range 140-270V.
		NRU: Narrow [02] N-U	If set NRU, the AC range 180-270V.
03	120V Mode Inverter voltage setting	110V(default) [03] 110 <sub>v</sub>	110/115/120V
	220V Mode Inverter voltage setting	220V(default) [03] 220 <sub>v</sub>	220/230/240V
04	Inverter frequency setting	50HZ(default) [04] 500 <sub>Hz</sub>	60HZ [04] 600 <sub>Hz</sub>
13	AC charging setting	Rated current(default) [13] 40 <sub>A</sub>	Range of adjustment: 10A - Rated current. Regulation step 5A
14	Battery type	acid (default) [14] Pb	Select the battery type (Lead acid or Lithium)
		Lithium [14] L	
		If "User-Defined" LI is selected, battery charge voltage and low DC cut-off voltage can be set up in program 17,18 and 19.	
17	Boost voltage setting	14.1V(default) [17] 14.1 <sub>v</sub>	Range of adjustment 12V-14.5V(12Vmodel) 24-29V(24Vmodel) 48-58V(48Vmodel)
18	Floating charging setting	13.5V(default) [18] 13.5 <sub>v</sub>	Range of adjustment 12V-14.5V(12Vmodel) 24-29V(24Vmodel) 48-58V(48Vmodel)
19	Battery low voltage shutdown point setting	10.5V(default) [19] 10.5 <sub>v</sub>	Range of adjustment 10-12V(12Vmodel) 20-24V(24Vmodel) 40-48V(48Vmodel)
20	SBU Battery low voltage power point	11.5V(default) [20] 11.5 <sub>v</sub>	Range of adjustment 10.5-13V(24Vx2/48Vx4) If you choice SBU, when the battery voltage less than value, the inverter will work in AC model

21	SBU Battery high voltage inverter point	13.5V(default) [21] 13.5 V	Range of adjustment 13V-14.0V(24Vx2/48Vx4) If you choice SBU, when the battery voltage more than value continue 1min, the inverter will work in DC model.
23	LCD back light settings	LCD ON [23] LON	The LCD back light on.
		LCD OFF(default) [23] LOF	Press any button to light up continue 1min.
24	Buzzer switch settings	Buzzer ON(default) [24] 6ON	Buzzer OFF [24] 6OF
27	Save mode switch settings	SEN [27] 5EN	Save mode enable inverter is set to detect the load every 5/30 seconds
		Sdi(default) [27] 5di	Save off The save model disenable.
28	Search time settings in Save mode	5s(default) [28] 5	5s inverter is set to detect the load every 5 seconds. 30s inverter is set to detect the load every 30 seconds.
29	AC charging switch settings	AC charging on(default) [29] UCE	AC charging off [29] UCd
37	BMS control method	Voltage method(default) [37] 40L	SOC Percentage method [37] 50C
38	Battery stop discharging percent When SOC is available	20 % (default) [38] 20 %	Setting range is from 5%-95% Increment of each click is 1 % .
39	Battery stop charging percent When SOC is available	95 % (default) [39] 95 %	Setting range is from 10%-100% Increment of each click is 1 % .
40	BMS communication	(default) [40] ,dP	when the communication between BMS and converter is faulted ,the converter still charge or discharge from the battery
		[40] Un1	when the communication between BMS and converter is faulted ,the converter stop charging or discharging from the battery
41	Lithium battery protocol	SEL[41] 0	Setting range is from 0 to 31 Increment of each click is 1
	UP	Page up key	
	DOWN	Page down key	
	ENTER	Confirm the exit key	



## AGS function

### AGS function information

The AGS function is that the inverter will start the generator automatically via the dry contact when the battery is low voltage.

Note:

The generator must have dry contact function.

If you connect AC grid and Generator to Inverter input at the same time, the interlock device should be installed between generator output and inverter input. (To ensure the utility and generator will not provide power to inverter at the same time. It doesn't need to be installed if only connect generator).

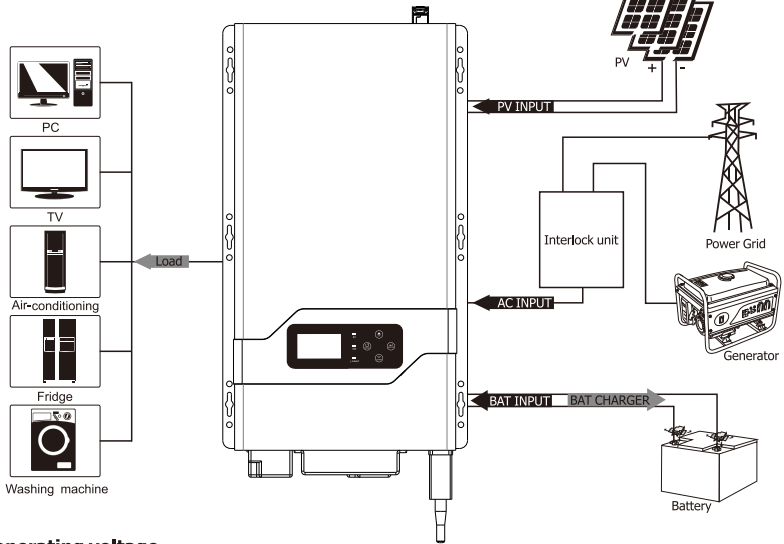

### Dry contact operating voltage

Set Low Shutdown Voltage	Operation Voltage	Restoring Voltage
10V/20V/40V	DC<10.5V/21V/42V	DC>13.5V/27V/54V
10.5V/21V/42V	DC<11V/22V/44V	DC>13.5V/27V/54V
11V/22V/44V	DC<11.5V/23V/46V	DC>13.5V/27V/54V
11.5V/23V/46V	DC<12V/24V/48V	DC>13.5V/27V/54V
12V/24V/48V	DC<12.5V/25V/50V	DC>13.5V/27V/54V

That is when the dry contact is engaged at  $DC < \text{set low shutdown point} + 0.5V$  (battery low voltage warning point), at  $DC > 13.5V$ . (12V model)

### BTS -CAN function:

- BMS communication connection, confirm that the setting content is correct, and the wiring is not abnormal, the inverter matching lithium battery communication protocol confirm that the setting is normal.



Port	Lithium battery		Inverter	
CAN communication port definition	PIN 1	NC(Empty)	PIN 1	NC(Empty)
	PIN 2	NC(Empty)	PIN 2	NC(Empty)
	PIN 3	NC(Empty)	PIN 3	NC(Empty)
	PIN 4	CANL	PIN 4	CANL
	PIN 5	CANH	PIN 5	CANH
	PIN 6	NC(Empty)	PIN 6	NC(Empty)
	PIN 7	NC(Empty)		
	PIN 8	NC(Empty)		

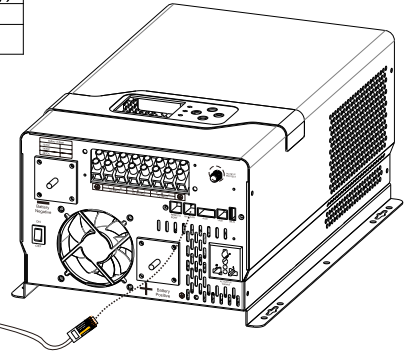

## Communication

### Computer Monitoring directions

- use the monitoring software: SolarPowerMonitor for communication. This software supports the communication function for various models of our company.
- The software will send the COM Port and inverter model automatically.

### The operation steps are as follows

- Connect the Inverter to Computer with USB cable.

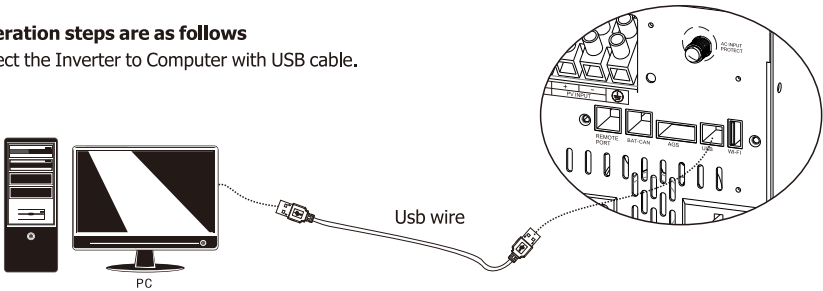

Install the software: Solar Power Monitor

Put the CD in the computer CD driver, Choose Solar Power Monitor.exe and install

communication

Open the PowerMonitor, turn on the machine.

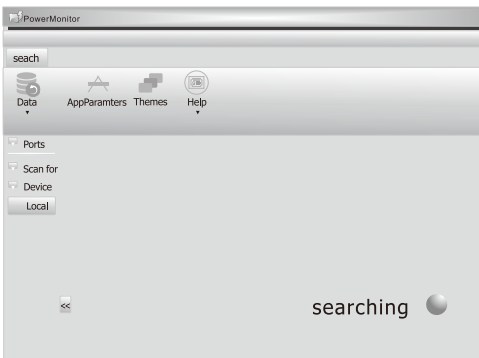

The SolarPowerMonitor will auto scan communication port.

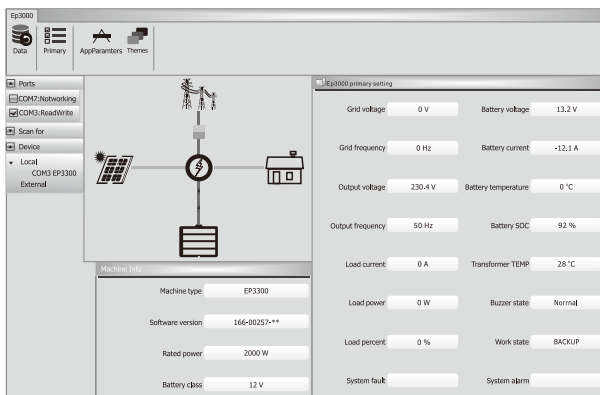

Wait for a moment, Power Monitor will work normally.

Monitor software function operation

Specific function Operations of the monitoring software, please refering to the HELP docs after the connection is successful.

## Specifications

### Inverter Mode Specification

Rated power(W)	1KW	1.5KW	2KW	3KW	4KW	5KW	6KW
Power Factor	1						
Wave form	Pure sine wave						
Output voltage RMS	110V/115V/120VAC(220V/230V/240VAC)±10%						
Output frequency	50HZ or 60HZ (±0.3HZ)						
Inverter efficiency(peak)	>80%						
Overload	100%<Load<110% (alarm 5min then stop output and fault code 07) 110%<Load<125% (alarm 60s then stop output and fault code 07) Load>125% (alarm 10s then stop output and fault code 07)						
Surge rating	3000VA	4500VA	6000VA	9000VA	12000VA	15000VA	15000VA
Capable of starting electric motor	1P		1.5P	1.5P	2P	3P	
Battery voltage	12VDC/24VDC			24VDC/48VDC			
Low battery cut off	(low voltage fault code04) (10/10.5/11/11.5/12V) for 12V model (20/21/22/23/24V) for 24V model (40/42/44/46/48V) for 48v model						
Low battery alarm	Add 0.5V/battery: (low battery alarm one second one time) (10/10.5/11/11.5/12V) +0.5Vdc for 12V model (20/21/22/23/24V) +1Vdc for 24v model (40/42/44/46/48V) +2Vdc for 48v model						
High voltage alarm	Add +1V/battery: (high voltage one second one time/after 30s fault 03) (12-14.5V) + 1V for 12V model (24-29V) + 2V for 24v model (48-58V) + 4V for 48v model						
Save mode	Load≤50±20W(120V)/100±20W(220V)						
Operating Temperature Range	-0°C to 40°C						
Storage Temperature	-15°C~ 60°C						
Audible Noise	60db max						



## AC Mode Specification

AC parameter

Input waveform	Pure sine wave
Nominal input voltage	120/230Vac ( $\pm 3\%$ )
Max input voltage	140/270Vac MAX
Input frequency	50HZ/60HZ (auto sensing)
Output waveform	Same as input waveform
Overload protection	Breaker + software protection
Output short circuit	Breaker+ software protection
Efficiency(AC mode)	>95% <sup>⑧</sup> load, full battery)
Transfer time AC TO DC	15ms(max)
Transfer time DC TO AC	15ms(max)

AC input voltage range: ( $\pm 5V$ )

model	range	Low cutoff	Low recover	High cutoff	High recover
120V	narrow	AC<90V	AC>95V	AC>140V	AC<135V
		F<40HZ	F>45HZ	F>70HZ	F<65HZ
	wide	AC<70V	AC>75V	AC>140V	AC<135V
		F<40HZ	F>45HZ	F>70HZ	F<65HZ
220V	narrow	AC<180V	AC>190V	AC>270V	AC<265V
		F<40HZ	F>45HZ	F>70HZ	F<65HZ
	wide	AC<140V	AC>150V	AC>270V	AC<265V
		F<40HZ	F>45HZ	F>70HZ	F<65HZ

## Charge Mode Specifications

Max charge current: ( $\pm 5A$ )

model	1K	1.5K	2K	3K	4K	5K	6K
12V	30A	45A	60A	60A			
24V	20A	25A	30A	40A	60A	60A	60A
48V	20A	20A	20A	20A	30A	35A	40A

Min charge current 10A. change by every 5A.

Charge mode AC range:

Setting	Low voltage	Charge mode	recover	Charge mode
120V AC wide range	AC>135V	Stop charge	AC<130V	Charge recover
	AC<75V	Stop charge	AC>80V	Charge recover
	40<F<70HZ charge			
220V AC wide range	AC>265V	Stop charge	AC<260V	Charge recover
	AC<155V	Stop charge	AC>160V	Charge recover
	40<F<70HZ charge			

## Solar charger(MPPT controller) electrical specification

Type	MPPT-80A			
Nominal system voltage	12V/24/48V(auto detection);			
Maximum charge current	80A $\pm$ 4A			
Battery voltage	12V	24V	36V	48V
Maximum solar input voltage	100 $\pm$ 2V	245 $\pm$ 2V		

PV array MPPT voltage range	15-95V	30-230V	45-230V	60-230V
Maximum input power	1250W	2500W	3750W	5000W
Charging stages	Bulk,absorption,float			
Over charging voltage	15.5V/30.0V/45.0V/60.0V			
Over charging comeback voltage	14.5V/29.5V/44.5V/59.0V			
Battery defect voltage	10.0V/17.0V/25.5V/34.0V			

Charge mode:

Charge current adjustable	Charge current adjustable: 10A min (adjust by every 5A)
Battery voltage	10-14.5Vdc/20-29Vdc/40-58Vdc
Short circuit protection	breaker
Over charge protection	Bat $V \geq$ charge voltage + 1V/battery, 1s 1 time for 30s then alarm 03
rule	Boost CC $\rightarrow$ Boost CV $\rightarrow$ Boost FV

Charging algorithm for lead acid battery(Lithium battery charging curveThe charging current in the float charging stage is 10A)

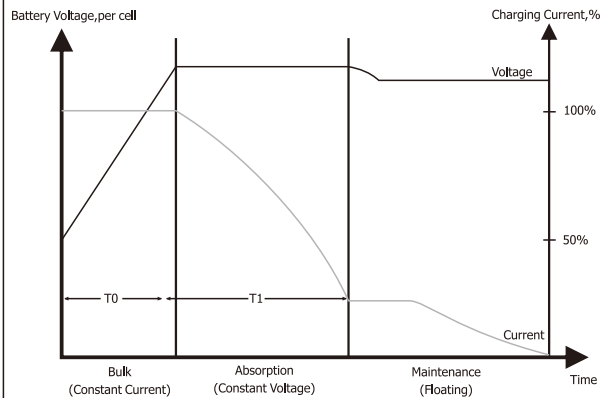

Charging algorithm for Lithium battery(Lithium battery charging curveThe charging current in the float charging stage is 10A)

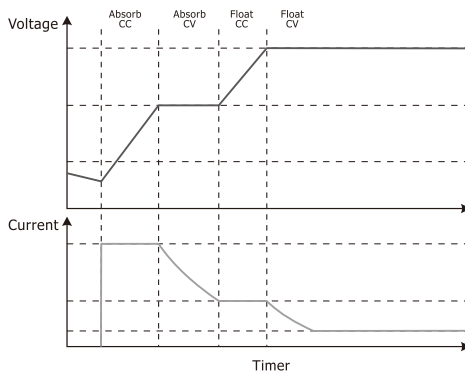

**Fault Mode**

## LED instruction











LED	LED state	information
LED AC(green)	Off	No AC input
	On	AC normal
	Blink	AC over range
LED Inv(yellow)	On	Inverter mode
LED Fault(red)	Off	normal
	On	fault
	Blink	caution

## BUZZER instruction

Buzzer state	information
Buzzer off	normal
Buzzer beep	caution
Buzzer on	fault

LCD display instruction

When inverter alarm, even it back to recovery mode. We must restart inverter to clear fault.

Fault code	Fault	Fault instruction
	Fan fault	Fan stop run
	Over temperature	BTS over temperature: $T_{battery} > 65^{\circ}\text{C}$ 1s 1 time for 1min then fault alarm 02; $T_{battery} < 60^{\circ}\text{C}$ recovery Inverter over temperature: $T_{inv} > 90^{\circ}\text{C}$ 1s 1time for 1min then fault alarm 02; $T_{inv} < 85^{\circ}\text{C}$ recovery
	DC voltage too high	Battery over voltage: $DC > V_{(charge\ voltage + 1V)/1.2V}$ alarm for 30s then fault code 03 Over voltage recovery: $DC < V_{(charge\ voltage + 1V) - 0.2V/1.2V}$
	DC voltage too low	Low voltage alarm: $DC < V_{(cutoff + 0.5V)/1.2V}$ Alarm recovery: $DC > V_{(cutoff + 0.5) + 0.2/1.2V}$ Low voltage fault: $DC < V_{cutoff}$ fault code 04
	Output short circuit in DC model	Output short circuit: short circuit test fault 05
	Output over voltage	Output over voltage: $V_{output} > 135V/270V$ 500ms fault 06
	Output over load	overload: $100\% < \text{Load} < 110\%$ alarm per every second (5min later inverter cutoff output and fault 07) $110\% < \text{Load} < 125\%$ alarm per every second (60s later inverter cutoff output and fault 07) $\text{Load} > 125\%$ alarm per every second (10s later cut off output and fault 07)
	Output over current	Inverter Output over current: 1-3K: $I_{rms} > 40A$ , 4-6K: $I_{rms} > 80A$ 200ms fault 51
	Communication failure BMS	1.The communication Line is not connected 2.The communication Line is poor contact
	Output low voltage in DC model	Output low voltage: $V_{output} < 85V/170V$ 500ms fault 58

## Trouble shooting

If machine enters into fault mode, please remove input power. And according to the table, deal with the following problems.

LED/Buzzer	LCD	Explanation / Possible cause	What to do
Buzzer beeps continuously and red LED is on	Fault code 01	Fan stop run	Check the fan.
	Fault code 02	Temperature of machine is too high.	Power off and waiting for minute
	Fault code 03	Battery voltage is too high.	Check the battery specifications
	Fault code 04	Battery voltage is too low.	Check the battery specifications
	Fault code 05	Output short circuited	Remove your load and restart
	Fault code 06	Inverter output voltage is high.	Return to repair center
	Fault code 07	Over load	Decrease your load
	Fault code 51	Output over current	Check if wiring is connected well and remove abnormal load.
	Fault code 58	Output voltage is too low.	Decrease your load

**MPPT controller warning:**

Warn code	Warn information	Warn information specification	What to do
[E0]▲	Hard ware protection		Return to repair center
[E1]▲	Over current		
[E2]▲	Current sensor error		
[E3]▲	MPPT controller over temperature		Stop PV charge soon
[E4]▲	PV voltage too high		Check PV
[E5]▲	PV voltage too low		
[E6]▲	Battery voltage too high		Check battery
[E7]▲	Battery voltage too low		
[E8]▲	Current is uncontrollable		Return to repair center
[E9]▲	Parameter error		
[E1]▲	MPPT controller fan		Check MPPT fan



**MUST**<sup>®</sup>

# GUARANTEE CERTIFICATE

Serial No.: \_\_\_\_\_

Customer's Name				Contact Person	
Address				Telephone No.	
Product/Model:		Post Code		Fax No.	
Date of purchase			Expire Date		
Dealer Signature			Customer Signature		

**MUST**<sup>®</sup>

# GUARANTEE CERTIFICATE

Serial No.: \_\_\_\_\_

Customer's Name				Contact Person	
Address				Telephone No.	
Product/Model:		Post Code		Fax No.	
Date of purchase			Expire Date		
Dealer Signature			Customer Signature		