



USER'S MANUAL

PV Grid Inverter

Please download the software "SolarPowerMonitor2.2.81".
Download link:<https://en.must-ee.com>



CONTENTS

1. Notes on this manual	1
2. Safety	3
3. Product description.....	6
4. Installation.....	8
5. Electrical Connection.....	12
6. Commissioning.....	18
7. Start-up and shut down the inverter.....	19
8. maintenance and Cleaning.....	19
9. Trouble shooting.....	19
10. Decommissioning.....	21
11. Technical Data.....	21
12. PV system installation.....	24
13. Contact.....	24

1. Notes on this manual

1.1 Validity and information

This manual describe the assembly, installation, commissioning and maintenance of the following PH5000 inverter model: PH50-2500 PH50-3000. The manual and other documents must be stored in a convenient place and be available at all times. For possible changes in this manual, we accepts no responsibilities to inform the users.

1.2 Target Group





This manual is for qualified personnel. Qualified personnel have received training and have demonstrated skills and knowledge in the construction and operation of this device. Qualified Personnel are trained to deal with the dangers and hazards involved in installing electric devices.

Any trouble in the installation, you can contact the supplier .









1.3 Symbols in this document

1.3.1 Warning in this document

A warning describes a hazard to equipment or personnel. It calls attention to a procedure or practice, which, if not correctly performed or adhered to, could result in damage to or destruction of part or all of the PH5000 equipment and/or other equipment connected to the PH5000 equipment or personal injury.

Symbol	description
	DANGER indicates a hazardous situation which, if not avoided, will result in death or serious injury.
	WARNING indicates a hazardous situation which, if not avoided, could result in death or serious injury.
	CAUTION indicates a hazardous situation which, if not avoided, could result in minor or moderate injury.
	NOTICE is used to address practices not related to personal injury.
	Information that you must read and know to ensure optimal operation of the system.

1.3.2 Markings on this product

Symbol	description
	Electrical voltage! Danger of high voltage and electric shock.
	Risk of burns! Danger of hot surface.
	Operation after 5 minutes Signals danger due to electrical shock and indicates the time(5 minutes) to allow after the inverter has been turned off and disconnected to ensure safety in any installation operation .
	CE mark. The inverter complies with the requirements of the applicable EC guidelines.
	Point of connection for grounding protection
	Direct Current (DC)
	Alternating Current (AC)
	The inverter has no transformer.
	Read the manual

1.4 Glossary

AC

Abbreviation for "Alternating Current"

DC

Abbreviation for "Direct Current"

Energy

Energy is measured in Wh (watt hours), kWh (kilowatt hours) or MWh (megawatt hours). The energy is the accumulation of power over time. for example, your inverter operates at a constant power of 5000 W for half an hour and then at a constant power of 2500 W for another half an hour, it has fed 3750Wh of energy into the power distribution grid within that hour.

Power

Power is measured in W (watts), kW (kilowatts) or MW (megawatts). Power is an instantaneous value. It displays the power your inverter is currently feeding into the power distribution grid.

Power rate

Power rate is the ratio of current power feeding into the power distribution grid and the maximum power of the inverter that can feed into the power distribution grid.

Power Factor

Power factor is the ratio of real power and apparent power. They are identical only when current and voltage are in phase and the power factor is 1.0. The power in an ac circuit is very seldom equal to the direct product of the volts and amperes. In order to find the power of a single phase ac circuit the product of volts and amperes must be multiplied by the power factor.

PV

Abbreviation for photovoltaic

wireless communication

The external wireless communication technology is a radio technology that allows the inverter and other communication products to communicate with each other. The external wireless communication does not require line of sight between the devices and it is selective purchasing.

2.Safety

2.1 Intended Use

The unit converts the DC current generated by the photovoltaic (PV) modules to grid-compliant alternating current and performs single-phase feed-in into the electricity Grid. The PH50-2500,PH50-3000 inverters are built according to all required safety rules. Nevertheless, improper use may cause lethal hazards for the operator or third parties, or may result in damage to the units and other property.

Principle of a PV plant with this PH50-XXXX single-phase inverter

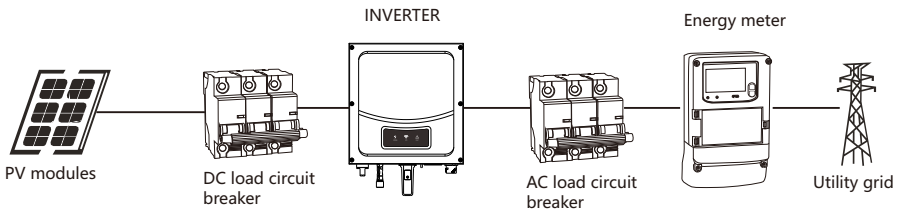

The inverter may only be operated with a permanent connection to the public power grid. The inverter is not intended for mobile use. Any other or additional use is not considered the intended use. The manufacturer/supplier is not liable for damage caused by such unintended use. Damage caused by such unintended use is at the sole risk of the operator.

PV modules Capacitive Discharge Currents

PV modules with large capacities relative to earth, such as thin-film PV modules with cells on a metallic substrate, may only be used if their coupling capacity does not exceed 470nF. During feed-in operation, a leakage current flows from the cells to earth, the size of which depends on the manner in which the PV modules are installed (e.g. foil on metal roof) and on the weather (rain, snow). This "normal" leakage current may not exceed 50mA due to the fact that the inverter would otherwise automatically disconnect from the electricity grid as a protective measure.



2.2 Qualification of skilled person

This grid-tied inverter system operates only when properly connected to the AC -distribution network. Before connecting the PH5000 to the power distribution grid, contact the local power distribution grid company. This connection must be made only by qualified technical personnel to connect, and only after receiving appropriate approvals, as required by the local authority having jurisdiction.

2.3 Safety instruction



The PH5000 Inverters is designed and tested according to international safety requirements; however, certain safety precautions must be observed when installing and operating this inverter. Read and follow all instructions, cautions and warnings in this installation manual. Any questions, please contact the supplier .

2.4 Assembly Warnings



 warning	<ul style="list-style-type: none">▶ Before installation, inspect the unit to ensure absence of any transport or handling damage, which could affect insulation integrity or safety clearances; otherwise it could result in safety hazards.▶ Assemble each inverter the instructions in this manual. Be Careful when choosing installation location and according to specified cooling requirements.▶ Unauthorized remove the necessary protections, improper use, incorrect installation and operation may result the serious safety and shock hazards or equipment damage.▶ In order to minimize the potential of a shock hazard due to hazardous voltages, cover the entire solar array with dark material prior to connecting the array to any equipment.
 caution	<ul style="list-style-type: none">▶ Grounding the PV modules:The PH5000 is a high frequency inverter(without transformer). That is why it has no galvanic separation. Do not ground the DC circuits of the PV modules when connected to the PH5000. Only ground the mounting frame of the PV modules.If you connect grounded PV modules to the PH5000, that will show error message "PV ISO Low".▶ Follow the local requirements for grounding the PV modules and the PV generator. We recommend connecting the generator frame and other electrically conductive surfaces in a manner which ensures continuous conduction with ground in order to have optimal protection of the system and personnel.

2.5 Electrical Connection Warnings

 danger	<ul style="list-style-type: none">▶ The components in the inverter are mobilizable. Touching mobilizable components can result in serious injury or death.<ul style="list-style-type: none">● Do not open the inverter except the wire box by qualified persons.● Electrical installation, repairs and conversions may only be carried out by electrically qualified persons.● Do not touch damaged inverter.▶ Danger to life due to high voltages in the inverter.<ul style="list-style-type: none">● There has residual voltage in the inverter. The inverter takes 20 minutes to discharge.● Wait 20 minutes before you open the wire box.▶ Persons with limited physical or mental abilities may only work with the PH5000 inverter following proper instruction and under constant supervision. Children are forbidden to play with the PH5000 inverter. Must keep the PH5000 inverter away from children.
--	--

 warning	<ul style="list-style-type: none"> ▶ Make all electrical connections (e.g. conductor termination, fuses, PE connection, etc.) in accordance with prevailing regulations. When working with the inverter, adhere to all prevailing safety regulations to minimize risk of accidents. ▶ Systems with inverters typically require additional control (e.g., switches, disconnects) or protective devices (e.g., fusing circuit breakers) depending on the prevailing safety rules. 				
 caution	<ul style="list-style-type: none"> ▶ The PH5000 Inverter converts DC Current from PV generator into AC current. The inverter is suitable for mounting indoors and outdoors. ▶ You can use the AC current generated as follows: <table border="1" data-bbox="165 368 998 654" style="width: 100%; border-collapse: collapse;"> <tr> <td data-bbox="165 368 317 564" style="width: 25%; padding: 5px;">House grid</td> <td data-bbox="317 368 998 564" style="padding: 5px;">Energy flows into the house grid. The consumers connected, for example, household devices or lighting, consume the energy. The energy left over is fed into the public grid. When the PH5000 is not generating any energy, e.g., at night, the consumers which are connected are supplied by the public grid. The PH5000 does not have its own energy meter. When energy is fed into the public grid, the energy meter spins backwards.</td> </tr> <tr> <td data-bbox="165 564 317 654" style="padding: 5px;">Public grid</td> <td data-bbox="317 564 998 654" style="padding: 5px;">Energy is fed directly into the public grid. The PH5000 is connected to a separate energy meter. The energy produced is compensated at a rate from the electric power company.</td> </tr> </table> 	House grid	Energy flows into the house grid. The consumers connected, for example, household devices or lighting, consume the energy. The energy left over is fed into the public grid. When the PH5000 is not generating any energy, e.g., at night, the consumers which are connected are supplied by the public grid. The PH5000 does not have its own energy meter. When energy is fed into the public grid, the energy meter spins backwards.	Public grid	Energy is fed directly into the public grid. The PH5000 is connected to a separate energy meter. The energy produced is compensated at a rate from the electric power company.
House grid	Energy flows into the house grid. The consumers connected, for example, household devices or lighting, consume the energy. The energy left over is fed into the public grid. When the PH5000 is not generating any energy, e.g., at night, the consumers which are connected are supplied by the public grid. The PH5000 does not have its own energy meter. When energy is fed into the public grid, the energy meter spins backwards.				
Public grid	Energy is fed directly into the public grid. The PH5000 is connected to a separate energy meter. The energy produced is compensated at a rate from the electric power company.				

2.6 Operation Warnings

 warning	<ul style="list-style-type: none"> ▶ Make sure all covers and doors closed and secure during operation.. ▶ Although designed meeting all safety requirements, some parts and surfaces of Inverter are still hot during operation. To reduce the risk of injury, do not touch the heat sink at the back of the PV-Inverter or nearby surfaces while Inverter is operating. ▶ Incorrect sizing of the PV plant may result in voltages which could destroy the inverter. The inverter display will read the error message "PV-Overvoltage!" <ul style="list-style-type: none"> ● Switch the rotary DC Disconnect to the Off position immediately. ● Contact installer.
 caution	<ul style="list-style-type: none"> ▶ All operations regarding transport, installation and start-up, including maintenance must be operated by qualified, trained personnel and in compliance with all prevailing codes and regulations. ▶ Anytime the inverter has been disconnected from the power network, please be much careful as some components can retain charge sufficient to create a shock hazard; to minimize occurrence of such conditions, please comply with all corresponding safety symbols and precautions and present on the unit and in this manual. ▶ In particular cases, there may still be interference for the specified application area despite maintaining standardized emission limit values (e.g. when sensitive equipment is located at the setup location or when the setup location is near radio or television receivers).In this case, the operator is obliged to take proper action to rectify the situation. ▶ Do not stay closer than 20 cm to the inverter for any time.

3. Product description

3.1 PH5000 Overview

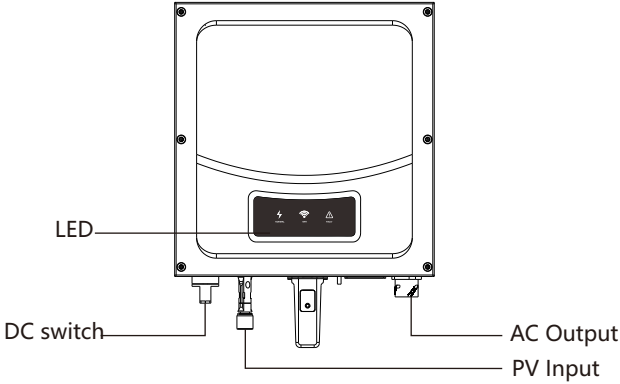

 information	The PH5000 series inverter can choose whether to bring a DC switch depending on customers' need.
--	--







Symbol on the inverter

Symbol	Description	Explanation
	Inverter status symbol	Indicates inverter operation status

3.2 Inverter label

The inverter can be identified by the label on the left side of inverter. It shows the Products type, the inverter specific features and the parameter on the label.

PV Grid Inverter	
Model Name	Ph50-****
DC max. voltage	***V
MPPT voltage range	**_***V
DC max. current	**A
AC nominal voltage	***V
Grid frequency	60Hz
Rated AC power	****W
Max. AC out apparent power	****VA
Max. AC current	***A
Power factor range	0.8c-0.8i
Protection degree	IP66
Protective class	Class I
Operation ambient temperature	-25°C~+60°C

Please kindly check the inverter detail specifications as below:

Model Name	PH50-2500	PH50-3000
Max input DC voltage	550V	
MPPT voltage range	100V-550V	
DC max.current	11A	
AC nominal voltage	220V	
Grid frequency	60HZ	
Rated AC power	2500W	3000W
Max.AC out apparent power	2500VA	3000VA
Max.AC current	11.4A	13.7A
Communications Ports	USB	
Protective class	Class I	
Protection degree	Ip66	
Operation ambient temperature	-25°C-60°C	

3.3 Inverter Dimensions

Dimensions and weight:

Model	Height (H)	Width (W)	Depth (D)	Weight
PH50-2500	368mm 14.5inch	262mm 10.3inch	155mm 6.1inch	9.5kg
PH50-3000	368mm 14.5inch	262mm 10.3inch	155mm 6.1inch	9.5kg

3.4 Storage environment of Inverter

If you want to storage the inverter in the warehouse, Please select a suitable place to storage.

- ▶ The inverter must be stored in original package and please keep stored in a dry environment
- ▶ The storage temperature should be always between -25°Cand +60°C. And the storage relative humidity should be always between 0 and 95%.(Recommend storage environment)
- ▶ If there are a batch of inverters need to be stored, the maximum layers for original carton is four.
- ▶ After long term storage, The local installer or Service centre should perform a comprehensive test before installation the inverter&system;

3.5 Advantage of the inverter:

- ▶ Wide input voltage range from 70--550Vdc
- ▶ IP66 protection degree
- ▶ Integrated DC switch
- ▶ DSP controller
- ▶ Fanless integrated cooling technology
- ▶ Multi MPP controller
- ▶ Easy installation

4.Installation



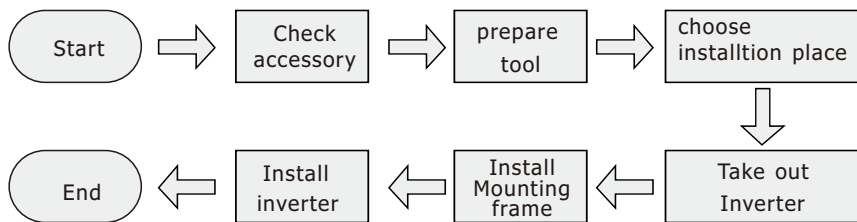



4.1 Installation step



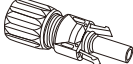
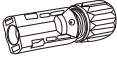

4.2 Unpacking and inspection



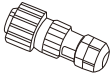

After opening the package, please check the contents of the box. It should contain the following, Please check all of the accessories in carton. If anything missing, please contact your dealer at once.

Shows the components and mechanical parts that should be delivered

NO.	Pictures	description	Quantity
1		PH5000	1PCS
2		Mounting frame	1PCS
3		PV+ input terminal	1PCS
4		PV- input terminal	1PCS
5		Metal terminals secured to PV+ input power cables	1PCS
6		Metal terminals secured to PV- input power cables	1PCS
7		Blasting screws	4PCS
8		M5 cross screws	2PCS

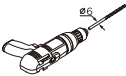
9		Output terminals	1PCS
10		Certificate	1PCS
11		Manual	1PCS

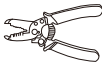
4.3 Tools

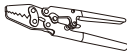
NO.	Tool	Model	Function
1		Hammer drill Recommend drill dia. 6mm	To drill holes on the wall
2		Removal tool	Remove PV terminal
3		Wire stripper	Strip wire
4		Wrench	Turn the screw to connect rear panel with inverter
5		Crimping tools	To crimp power cables

4.4 Selecting the installation location

- ▶ This is guidance for installer to choose a suitable installation location, to avoid potential damages to device and operators.
- ▶ The installation location must be suitable for the inverter's weight and dimensions for a long period time.
- ▶ Select the installation location so that the status display can be easily viewed.
- ▶ Do not install the inverter on structures constructed of flammable or thermolabile materials.
- ▶ Never install the inverter in environment of little or no air flow, nor dust environment. That may derate the efficiency of the cooling fan of the inverter.
- ▶ The Ingress Protection rate is IP66 which means the inverter can be installed outdoors and indoors.
- ▶ The humidity of the installation location should be 0~95% without condensation.
- ▶ The installation location must be freely and safely to get at all times.
- ▶ Vertically installation and make sure the connection of inverter must be downwards. Never install horizontal and avoids forward and sideways tilt.

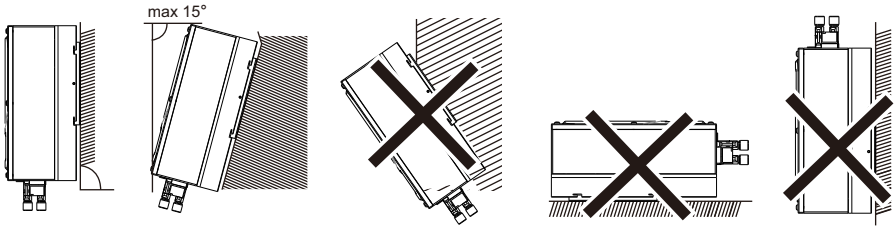

- ▶ Be sure that the inverter is out of the children's reach.
- ▶ Don't put any things on the inverter. Do not cover the inverter.
- ▶ Do not install the inverter near television antenna or any other antennas and antenna cables.
- ▶ Inverter requires adequate cooling space. Providing better ventilation for the inverter to ensure the heat escape adequately. The ambient temperature should be below 40°C to ensure optimum operation.
- ▶ Do not expose the inverter to direct sunlight, as this can cause excessive heating and thus power reduction.
- ▶ Observe the Min. clearances to walls, other inverters, or objects as shown in the diagram:

Direction	Min. clearance (cm)
above	80
below	50
sides	50
front	30

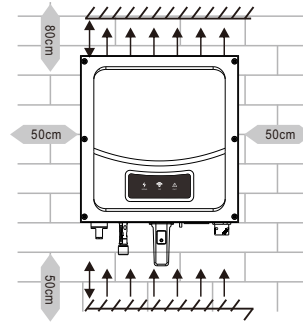

Ambient dimensions of **one inverter**

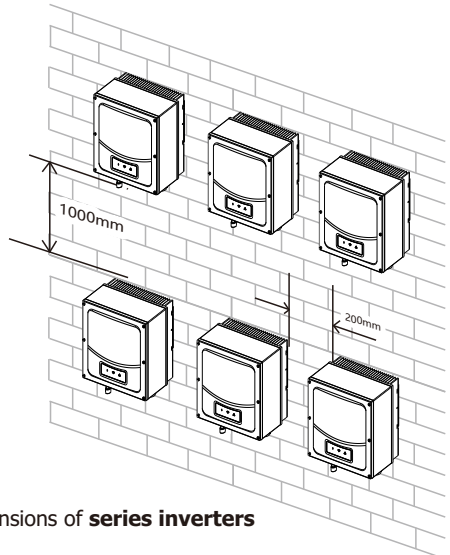
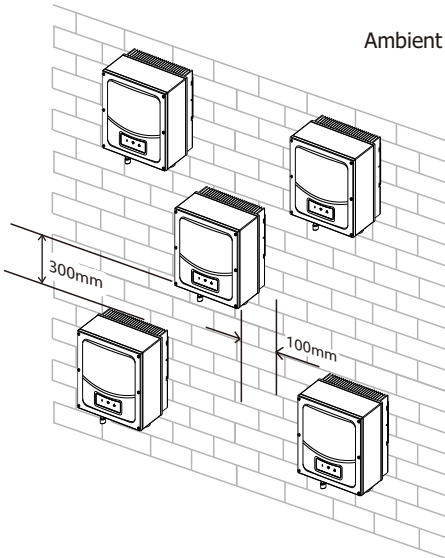

Ambient dimensions of **series inverters**

- ▶ There must be sufficient clearance between the individual inverters to ensure that the cooling air of the adjacent inverter is not taken in.
 - ▶ If necessary, increase the clearance spaces and make sure there is enough fresh air supply to ensure sufficient cooling of the inverters.
- The inverter can't install to solarization, drench, firm location. We suggest that the inverters should be installed at the location with some cover or protection.

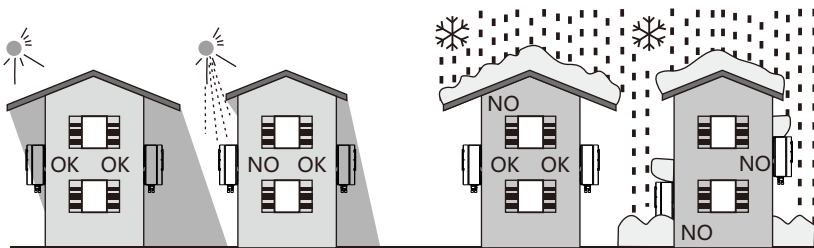

- ▶ Please make sure the inverter is installed at the right place. The inverter can't install close to trunk.

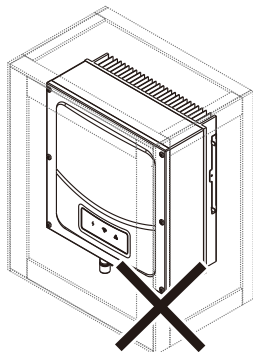

4.5 Mounting the Inverter

4.5.1 Mounting the Inverter with bracket



In order to avoid electrical shock or other injury, inspect existing electronic or plumbing installations before drilling holes.

- Using the mounting frame as a template, drill 4 holes as illustrated in image.

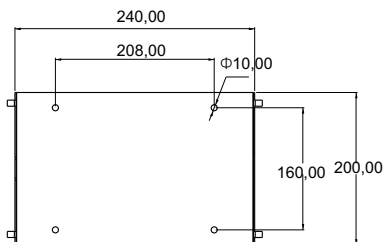

(图a)

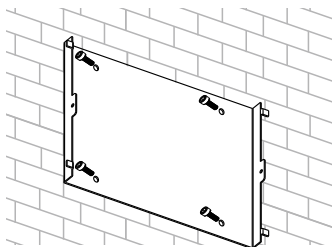

(图b)

step:

1.Align the mounting frame with hole positions, fix the mounting frame on the wall by tightening the expansion bolt with the nuts.

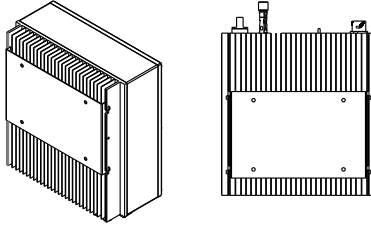

2.Hook the inverter to the rear panel. Using an M5 screw to secure the inverter to the mounting frame to ensure safety.

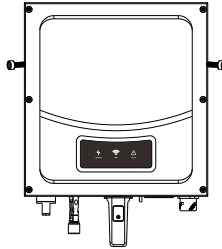

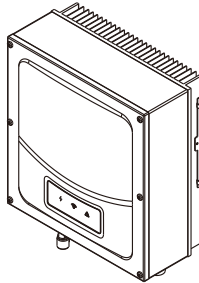

3.make sure all screws install in place.





5.Electrical connection

5.1 safety

	<p>Danger to life due to lethal voltages! High voltages which may cause electric shocks are present in the conductive parts of the inverter. Prior to performing any work on the inverter, disconnect the inverter on the AC and DC sides</p>
	<p>Danger of damage to electronic components due to electrostatic discharge. Take appropriate ESD precautions when replacing and installing the inverter.</p>

5.2 Wiring AC Output

	<p>▶ You must install a separate single-phase circuit-breaker or other load disconnection unit for each inverter in order to ensure that the inverter can be safely disconnected under load.</p> <p>● NOTE: The inverter has the residual current detect and protect function, if you have a device the AC breaker has the residual current detect function, you must choose a breaker with a rating residual current more than 300mA.</p>
	<p>▶ When using an inverter with VDE-AR-N 4105, because the inverter's displacement factor adjustment function has to be according to VDE-AR-N 4105, the PV-inverter system total capacity cannot be over 13.8KVA.</p> <p>● When using an inverter with CEI 0-21: if the inverter system total capacity is more than 3KW and up to 11.08KW, the displacement factor is adjustable between 0.95 leading to 0.95 lagging, and does not need the external SPI. If the inverter system total capacity is more than 11.08KW, the displacement factor is adjustable between 0.9 leading to 0.9 lagging, and needs the external SPI.</p>

You must install a separate single-phase circuit-breaker or other load disconnection unit for each inverter in order to ensure that the inverter can be safely disconnected under load. We suggest you choose the AC breaker rating current in this table:

PH50-2500	18A/220V
PH50-3000	20A/220V

We recommend electrical connection as below

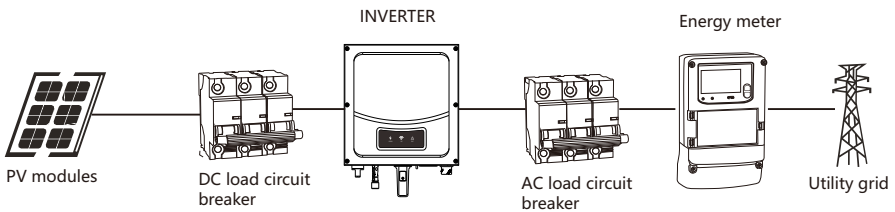

The AC wiring step

1. The grid connection is contained using 3 conductors (L1, L2, and PE).

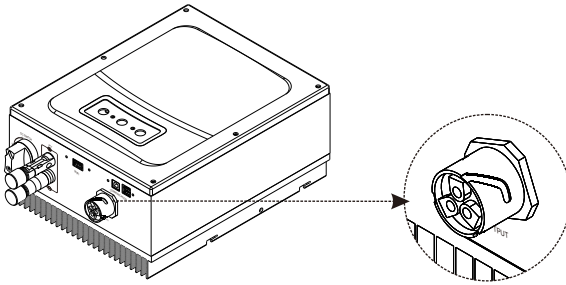

2. Remove the parts of the AC connection plug from the accessory bag. Prepare the pressure screw, sealing ring, threaded sleeve over the AC cable

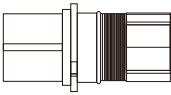

socket element

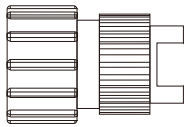

threaded sleeve



sealing ring



pressure screw

3. Insert the stripped and bared conductors L1,L2,and PE screw terminals with sign L1,L2,and PE socket element and tighten the screws firmly.

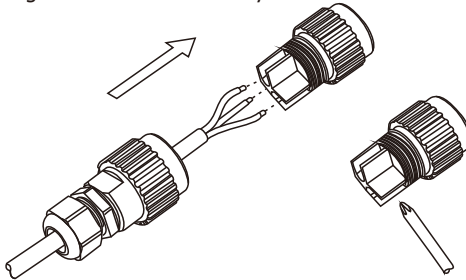

notice

Note that the polarity of the connection line matches the terminal tag to avoid incorrect connection.

4. Push the threaded sleeve into the socket element; screw the pressure screw tightly onto the threaded sleeve;

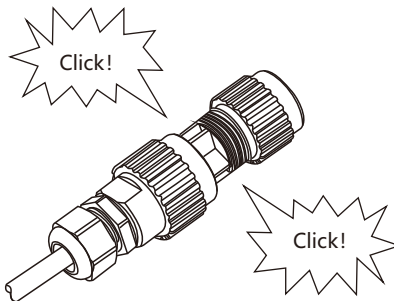

5. Finally, insert the AC connection plug into the AC connection receptacle on the inverter.

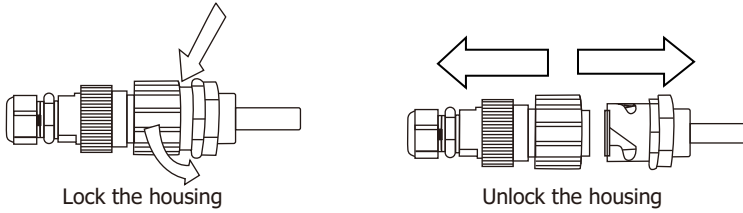

Wire suggestion length:

Conductor cross section	Max. cable length	
	PH50-2500	PH50-3000
5.2mm ² 10AWG	58m	48m
3.3mm ² 12AWG	36m	30m

5.3 Protect the earth

If the installation is required, the grounding terminal may be used to connect to the secondary protective earthing terminal or as an equipotential connection, as shown in the figure below.

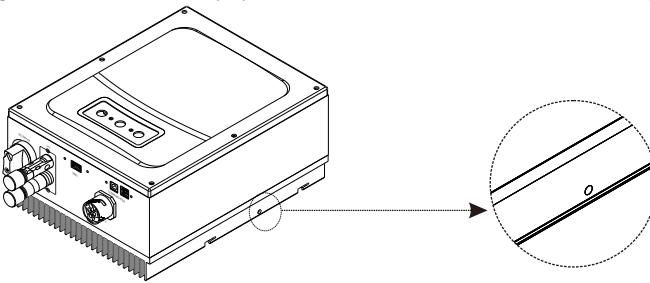

5.4 Wiring DC Input

5.4.1 Connecting DC Input Power Cables

Step1 Remove cable glands from the positive and negative connectors.

Step2 Take out metal terminals from accessory package ,Wiring as illustrated in image.

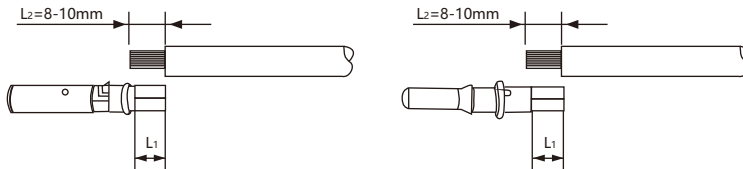

Step3 Insert the positive and negative power cables into corresponding cable glands.

Step4 Insert the stripped positive and negative power cables into the positive and negative metal terminals respectively and crimp them using a crimping tool. Ensure that the cables are crimped until they cannot be pulled out by force less than 400 N, as shown in image.

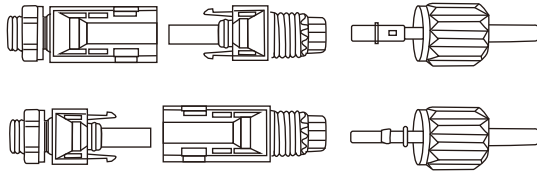

Step 5 Insert the positive and negative connectors into corresponding DC input terminals of the PH5000 until you hear a "click" sound.

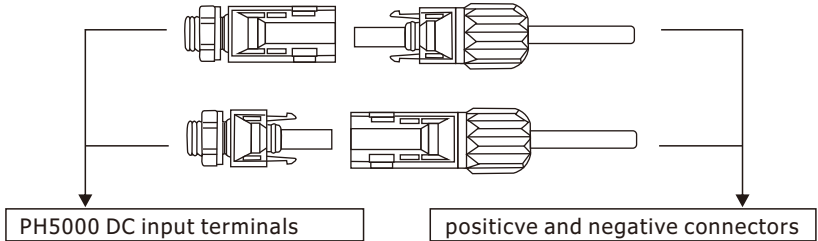

5.4.2 Conditions for DC Connection

The PH50-2500 and PH50-3000 single-phase inverter has 1 independent input

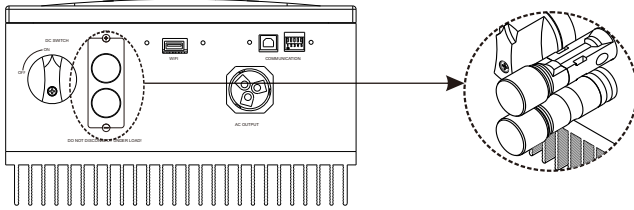

The diagram drawing of DC side is shown as below, notice that the connectors are in paired (male and female connectors). The connectors for PV arrays and inverters are H4 (yunfan) connectors;

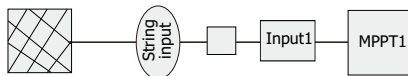



Suggestions for the PV modules of the connected strings:

- ▶ Same type
- ▶ Same quantity of PV modules connected in series

 caution	<p>If the inverter is not equipped with a DC switch but this is mandatory in the country of installation, install an external DC switch. The following limit values at the DC input of the inverter must not be exceeded:</p>	
	Model name	Max.current input
	PH50-2500	11A
	PH50-3000	11A

5.4.3 Connecting the PV Array (DC input)

 danger	<p>Before connecting the PV array, ensure that the DC switch and AC breaker are disconnect from the inverter. NEVER connect or disconnect the DC connectors under load. Make sure the maximum open circuit voltage(Voc) of each PV string is less than 550Vdc. Check the design of the PV plant. The Max. open circuit voltage, which can occur at solar panels temperature of -10°C, must not exceed the Max. input voltage of the inverter.</p>
 warning	<p>Improper operation during the wiring process can cause fatal injury to operator or unrecoverable damage to the inverter. Only qualified personnel can perform the wiring work.</p>

5.5 Grounding the inverter

The inverter must be connected to the AC grounding conductor of the power distribution grid via the ground terminal (PE)⚡.

 warning	<p>Because of the transformerless design, the DC positive pole and DC negative pole of PV arrays are not permitted to be grounded.</p>
---	--

6. Commissioning

6.1 LED display

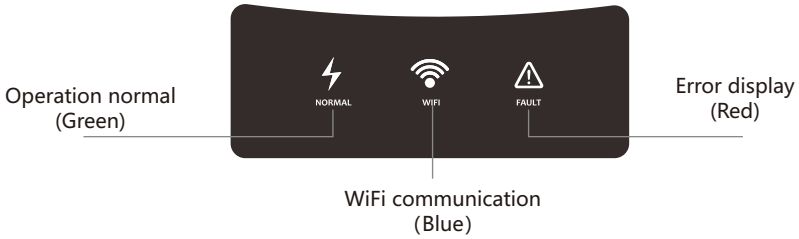

Green LED	Continuous light	Normal status
	Flicker	Waiting status
Blue LED	Flicker	Wifi normal communication
Red LED	Continuous light	Fault status
	Flicker	Program of procedure or give an alarm

6.2 WIFI Communication Connection

Please refer to the Wi-Fi Plug14 Quick Installation Guideline.

7.Start-Up and shut down the inverter

7.1 Start-Up the inverter

1. Connect the AC breaker of the inverter.
2. Turn on the dc switch, and the inverter will start automatically when the input voltage is higher than 100V.

7.2 Turn-off the Inverter

	Do not disconnect the DC connectors under load.
--	---

Turn –off the inverter step:

- Disconnect the line circuit breaker from single-phases grid and prevent it from being reactivated.
- Turn off the dc switch.
- Check the inverter operating status.
- Waiting until LED, display have go out, the inverter is shut down.

8.Maintenance and Cleaning

8.1 Checking Heat Dissipation

If the inverter regularly reduces its output power due to high temperature, please improve the heat dissipation condition. Maybe you need to clean the heat sink.

8.2 Cleaning the Inverter

If the inverter is dirty, turn-off the AC breaker and DC switch ,waiting the inverter shut down ,then clean the enclosure lid, the display, and the LEDs using only a wet cloth. Do not use any cleaning agents (e.g. solvents or abrasives).

8.3 Checking the DC Disconnect

Check for externally visible damage and discoloration of the DC Disconnect and the cables at regular intervals.If there is any visible damage to the DC Disconnect, or visible discoloration or damage to the cables, contact the installer.

Once a year, turn the rotary switch of the DC Disconnect from the On position to the Off position 5 times in succession. This cleans the contacts of the rotary switch and prolongs the electrical endurance of the DC Disconnect.contacts of the rotary switch and prolongs the electrical endurance of the DC Disconnect.

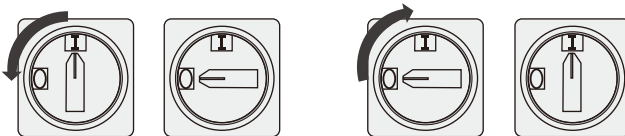

9.Trouble shooting

Sometimes, the PV inverter does not work normally, we recommend the following solutions for common troubleshooting. The following table can help the technician to understand the problem and take action.

Error message	Description	Suggestion
NO Utility	No utility grid connected or utility grid power failure.	1.Check AC wiring, especially the ground wire 2.Contact the installation contractor or supplier
Inverter temperature fault	NTC error	1.Restart inverter. 2.If error message still exists, contact the installation contractor or supplier.
PV High fault	The DC input voltage is exceeding the Maximum tolerable value.	1.Disconnect the DC switch immediately.
Grid voltage fault	Utility grid voltage is out of permissible range.	1.Check grid voltage. 2.If the error message still exists despite the grid voltage being within the tolerable range, contact the installation contractor or supplier.
Grid frequency fault	Utility grid Frequency out of permissible range.	1.Check grid frequency. 2.If the error message is displayed despite the grid frequency being within the tolerable range, contact the installation contractor or supplier.
PV ISO fault	Insulation problem	1.Check if panel enclosure ground properly. 2.Check if inverter ground properly. 3.Check if the DC breaker gets wet. 4.If the error message is displayed despite the above checking passed, contact the installation contractor or supplier.
DCI High	Output current DC offset too high	1.Restart inverter. If error message still exists, contact the installation contractor or supplier.
GFCI damage	GFCI Device Damage	1.Restart inverter. 2.If error message still exists, contact the installation contractor or supplier.
Hall sensor fault	HCT fault	1.Restart inverter. 2.If error message still exists, contact the installation contractor or supplier.
Rely fault	Rely error	1.Restart inverter. 2.If error message still exists, contact the installation contractor or supplier.
Communication fault	CPU communication fault	1.Restart inverter. 2.If error message still exists, contact the installation contractor or supplier.
Soft FW fault	Soft FW Don't match	1.Restart inverter. 2.If error message still exists, contact the installation contractor or supplier.
PE fault	No grounding wire or poor contact.	1.check PE If error message still exists, contact the installation contractor or supplier.

Note: If the suggestions do not work, please connect to the the installation contractor or supplier.

10. Decommissioning

10.1 Dismantling the Inverter

1. Disconnect the inverter as described in section 7.
2. Remove all connection cables from the inverter.

	<p>Danger of burn injuries due to hot enclosure parts! Wait 20 minutes before disassembling until the housing has cooled down.</p>
---	---

3. Screw off all projecting cable glands.
4. Lift the inverter off the bracket and unscrew the bracket screws.

10.2 Packing the Inverter

If possible, always pack the inverter in its original carton and secure it with tension belts. If it is no longer available, you can also use an equivalent carton. The box must be capable of being closed completely and made to support both the weight and the size of the inverter.

10.3 Storing the Inverter

Store the inverter in a dry place where ambient temperatures are always between -25°C and +60°C.

10.4 Disposing of the Inverter



Do not dispose of faulty inverters or accessories together with household waste. Please accordance with the disposal regulations for electronic waste which apply at the installation site at that time. Ensure that the old unit and, where applicable, any accessories are disposed of in a proper manner

11. Technical Data

11.1 Specifications

Model	PH50-2500	PH50-3000
Input data (DC)		
Max. recommended PV power (for module STC)	2875W	3450W
Max. DC voltage	550V	
Start voltage	100V	
PV voltage range	70V-550V	
MPP work voltage rang/nominal voltage	80V-550V/360V	
Full load dc voltage range	235-500V	281-500V
Max. input current per string of tracker A/ tracker B	11A	

Number of independent MPP trackers /strings per MPP tracker	1/1	
DC connection	H4/MC4	
Output (AC)		
Rated AC output power	2500W	3000W
Max.AC apparent power	2500VA	3000VA
Max.output current	11.4A	13.7A
AC nominal voltage range	220V;180Vac-280Vac	
AC grid frequency range	60±5Hz	
Phase factor at rate power	1	
Displacement power factor, configurable	0.8leading...0.8lagging	
THDI	< 3%	
AC connection	Single phase	
Efficiency		
Max. efficiency	97.40%	
Euro weighted efficiency	97%	
MPPT efficiency	99.50%	
Protection devices		
Island protection	yes	
Output over current protection	yes	
Output over voltage protection - varistor	yes	
DC reverse polarity protection	yes	
DC switch rating for each MPPT	yes(opt.)	
Ground fault monitoring	yes	
Integrated all-pole sensitive leakage current monitoring unit	yes	
General Data, Features		

Dimensions (W/H/D) in mm	262*368*155
Weight	10kg
Operation temperature range	-25°C- +60°C with derating above 45°C
Noise emission(typical)	≤25dB(A)
Altitude	2000m(6560ft) without derating
Self-consumption night	< 1W
topology	transformerless
Cooling concept	Natural
Environmental protection Rating	Ip66
Relative humidity	95%
AC connection	connector
Display	LED
Interfaces:USB/WI-FI/ Ethernet	yes/yes/opt.
Warranty	5 years/10years (opt.)
Certificates and approvals	NBT32004-2013/VDE0126/AS4777

11.2 Accessories

We offers 5 years product warranty for PH5000 series inverters from date of installation. However the warranty period can't exceed 66 months from the date of delivery of the inverter. During the warranty period, We guarantees normal operation of the inverter. During the warranty period, if the inverter is defective or faulty, please contact your installation contractor or supplier. If the fault is PH5000's responsibility,we will provide service and maintenance free of charge.

12.PV system installation

Installation with multiple inverters on a split phase system

(A) Single inverter

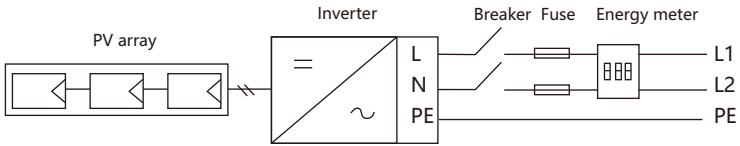

(B) multi inverter

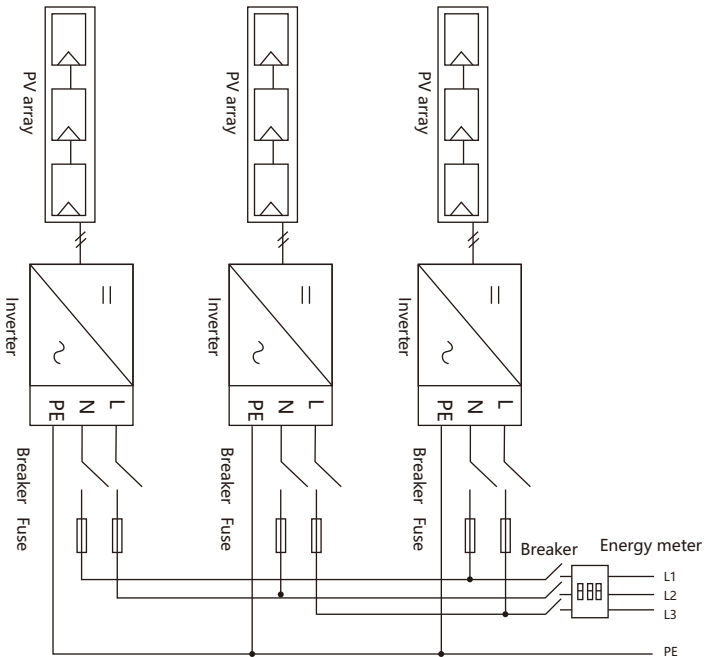

13 Contact

If you have technical problems about our products, contact the installation contractor or supplier .

We need the following information in order to provide you with the necessary assistance:

- ▶ Inverter type
- ▶ Inverter error messages
- ▶ Inverter LED display
- ▶ Type and number of PV modules connected
- ▶ Optional equipment

**MUST**[®]

GUARANTEECERTIFICATE

Serial No.: _____

Customer's Name				Contact Person	
Address				Telephone No.	
Product/Model:		Post Code		Fax No.	
Date of purchase			Expire Date		
Dealer Signature			Customer Signature		

**MUST**[®]

GUARANTEECERTIFICATE

Serial No.: _____

Customer's Name				Contact Person	
Address				Telephone No.	
Product/Model:		Post Code		Fax No.	
Date of purchase			Expire Date		
Dealer Signature			Customer Signature		