

USER'S MANUAL

Online UPS

1-10K (LV)

Please download the software "PowerManagerII V1.0".
Oversea: <https://bit.ly/2PyLg6>



Scan QR code for manual



Appliances



PC



POS



Printer



Type
scanner



Surveillance

Please read it carefully and keep this manual properly.

Thank you for choosing our UPS, you will get high-performance products and perfect after-sales service. Read this user manual carefully before using the UPS so that the system can be used correctly. If you encounter any problems during use, please refer to this manual before calling the distributor.

The following cases are not within the scope of warranty:

- (1) Out of warranty.
- (2) Series number was changed or lost.
- (3) Battery capacity was declined or external damaged.
- (4) UPS was damaged caused of transport shift, remissness, ectexternal factor.
- (5) UPS was damaged caused of irresistible natural disasters.
- (6) Not in accordance with the electrical power supply conditions or operate environment caused damage.

Safety Precautions

Operational safety

1. Before using this product, please read the "Safety Precautions" carefully to ensure correct and safe use. And please keep the manual properly
2. When operating, please pay attention to all warning signs and operate as required
3. Avoid using the device in direct sunlight, drenching or damp environment
4. This equipment cannot be installed in areas close to heat sources, or near electric heaters, hot stoves and other similar equipment
5. When placing the UPS, keep a safe distance around it to ensure wind transmission. When installing, please refer to the manual
6. When cleaning, please use a dry item to wipe
7. In case of fire, please use dry powder fire extinguisher correctly to extinguish the fire. If you use a liquid fire extinguisher, there is a risk of electric shock

Electrical Safety

1. Before powering on, please make sure that it is properly grounded, and check that the wiring and battery polarity are connected correctly
2. When the UPS needs to be moved or re-wired, the AC input power should be disconnected and the UPS should be completely shut down, otherwise the output terminal may still be live and there is a danger of electric shock.
3. Please use the specified attachments and accessories
4. In order to comply with EMC requirements, the length of the UPS output cable should be within 10 meters

Battery safety

1. The life of the battery decreases as the ambient temperature increases. Regular replacement of the battery can ensure the normal operation of the UPS and ensure sufficient backup time
2. Battery maintenance can only be carried out by personnel with professional knowledge of batteries
3. There is a danger of electric shock and short-circuit current from the battery. In order to avoid electric shock and injury, please observe the following warnings when replacing the battery
 - A. Do not wear watches, rings or similar metal objects
 - B. Use insulated tools
 - C. Wear rubber shoes and gloves
 - D. Do not put metal tools or similar metal parts on the battery
 - E. Before removing the battery connection terminal, the load connected to the battery must be disconnected
1. Please do not expose the battery to fire, so as not to cause an explosion and endanger personal safety
2. Non-professionals do not open or damage the battery, because the electrolyte in the battery contains dangerous substances such as strong acid, which can cause damage to the skin and eyes. If you accidentally come into contact with the electrolyte, you should wash it immediately with a lot of water and go to the hospital for inspection
3. Please do not short-circuit the positive and negative of the battery, which may cause electric shock or fire

Use and maintenance

1. The use environment and storage method have a certain impact on the service life and reliability of this product, please do not use it in the following working environment
 - A. High, low temperature and humid places exceeding the technical specifications (temperature 0~40°C, relative humidity 20%~95%)
 - B. Places subject to vibration and susceptibility to cover
 - C. Places with metallic dust, corrosive substances, salt and flammable gas
2. If it is left unused for a long time, the UPS (without battery) must be stored in a dry environment with a storage temperature range of -15°C~+60°C. Before the UPS is turned on, the ambient temperature must be warmed to above 0°C and maintained for more than 2 hours.

INDEX

1. Introduction.....	1
1.1 Symbol description.....	1
1.2 Real View.....	2
1.3 Product Parameter.....	4
2. installation.....	6
2.1 Unpacking and inspection.....	6
2.2 Notes for installation	6
2.3 Installation.....	7
2.4. Wiring table.....	8
2.5 Connection.....	8
2.6 Connect to a computer interface.....	10
2.7 Smart card installation.....	11
2.8 EPO	12
2.9 Maintenance switches	12
3. panel operation instructions.....	13
3.1 Panel Description.....	13
3.2 Key function.....	13
3.3 LED indicator functions.....	14
3.4 LCD function display.....	14
3.5 UPS working status table for indicator light.....	15
3.6 Daily on and off.....	16
3.7 Parameter Query Operation.....	17
Chapter 4 Notes for battery disposal.....	20
Chapter 5 Notes for battery disposal.....	25
Chapter 6 Trouble shooting.....	27











1. Introduction

This series of UPS is an advanced online sine wave uninterruptible power supply system with a bypass maintenance switch, which can provide you with reliable and high-quality AC power for your precision equipment. It has a wide range of applications, include computer equipment , Communication system and industrial automatic control equipment. Because of its on-line design, it is different from the backup UPS. It continuously adjusts and filters the input voltage. When the mains power is interrupted, it will provide backup power from the backup battery without time interruption. In the case of overload or inverter failure, the UPS will transfer to the bypass state and be powered by the mains. If the overload condition is eliminated, the UPS will automatically switch back to the inverter power supply state.

This manual applies to the following products, including:

- 1K: Standard model with built-in battery
- 1KS: long back-up model with external battery,
- 2K: Standard model with built-in battery.
- 2KS: long back-up model with external battery,
- 3K: Standard model with built-in battery.
- 3KS: long back-up model with external battery.
- 6K: Standard model with built-in battery.
- 6KS: long back-up model with external battery.
- 10K: Standard model with built-in battery.
- 10KS: long back-up model with external battery.

1.1 Symbol description

Symbols and meaning	
Symbol	meaning
	Caution
	Danger
	Alternating current
	Direct current
	Protective grounding conductor
	Protect the connecting conductor
	Cycle
	Do not place it with other objects
	Overload
	Battery
	Switch machine

1. 2 Rear View

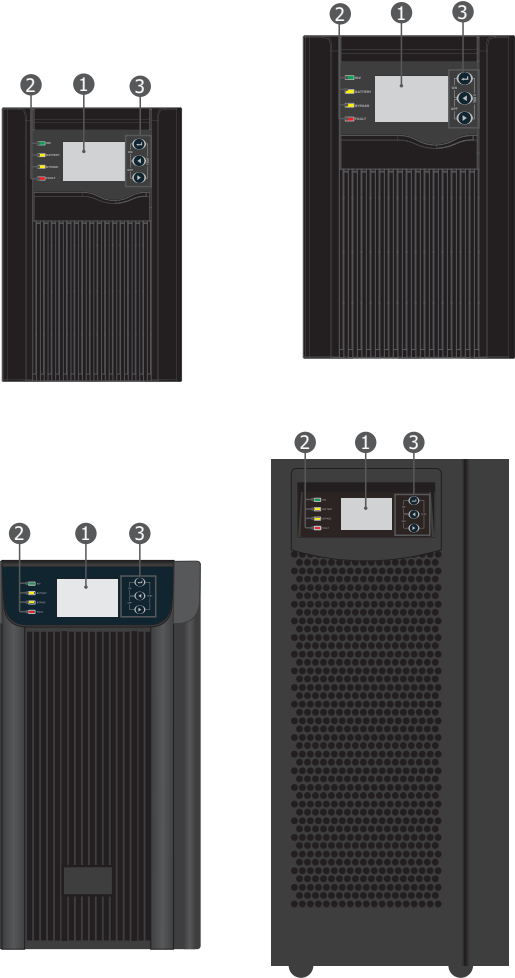

1. LCD display

2. LED indicator

3. Function buttons

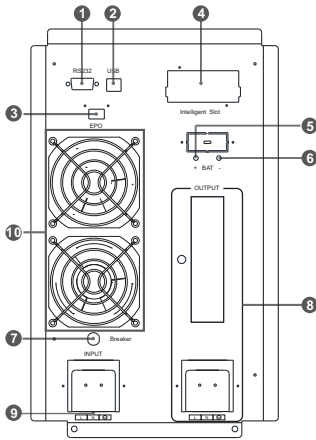

- 1 RS232 communication port
- 2 USB communication port
- 3 EPO port
- 4 Intelligent Slot
- 5 Battery +
- 6 Battery -
- 7 Circuit breaker
- 8 AC Output
- 9 AC Input
- 10 Fan

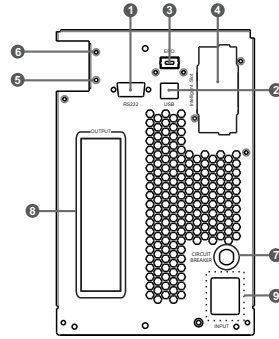

- 1 RS232 communication port
- 2 USB communication port
- 3 Intelligent Slot
- 4 Intelligent Slot
- 5 Battery +
- 6 Battery -
- 7 Circuit breaker
- 8 AC Output
- 9 AC Input
- 10 Fan

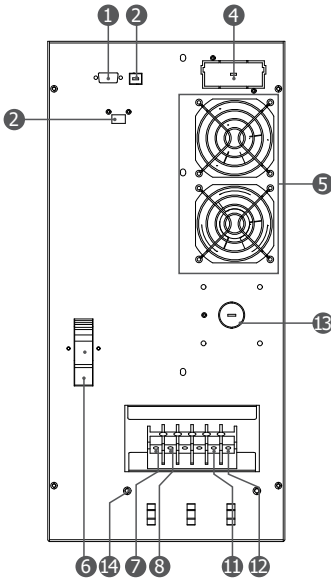

- 1 RS232 communication port
- 2 USB communication port
- 3 EPO port
- 4 Intelligent Slot
- 5 Fan
- 6 Input Switch
- 7 AC Input N
- 8 AC Input L
- 9 Battery +
- 11 AC Output L
- 12 AC Output N
- 13 Maintain Switch Cover(Optional)
- 14 Ground

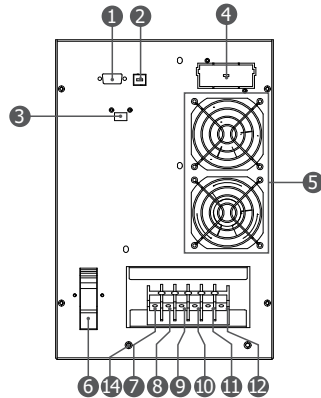

- 1 RS232 communication port
- 2 USB communication port
- 3 EPO port
- 4 Intelligent Slot
- 5 Fan
- 6 Input Switch
- 7 AC Input N
- 8 AC Input L
- 9 Battery +
- 10 Battery -
- 11 AC Output L
- 12 AC Output N
- 14 Ground

1. 3 Product Parameter

Model		1K	1KS	2K	2KS	3K	3KS
Capacity	1.0	1KVA/1KW		2KVA/2KW		3KVA/3KW	
AC Input							
Input Wiring		L+N+PE					
Nominated Input Voltage		100/110/115/120/127VAC					
Voltage Range		55~150VAC					
Frequency Range		50/60±HZ · ±10HZ(settable)					
Power Factor		≥0.99					
Harmonic distortion		≤3%THD (Linear load) ≤8%THD (Nonlinear load) (PF=0.8)					
AC output							
Output Wiring		L+N+PE					
Voltage		100/110/115/120/127VAC					
Precision		±1%					
Frequency		50/60Hz+0.1% On-Line Mode: Follow Grid frequency Battery Mode: 50/60Hz±0.1%					
Harmonic distortion		≤2%THD (Linear load) ≤5%THD (Nonlinear load) (PF=0.8)					
Power Factor		1					
Transfer Time		Utility to Battery: 0ms Inverter to bypass: 4ms					
Over Load		Utility Mode		Battery Mode			
		10min@102%~110%Load		1min@102%~110%Load			
		10min@110%~130%Load		10s@110%~130%Load			
		10s@130%~150%Load		3s@130%~150%Load			
		200ms@>150%Load		200ms@>150%Load			
UPS Efficiency							
Utility Mode(Full load)		93.5%@220VAC		95%@220VAC		94%@220VAC	
Battery Mode(Full load)		88.5%@36VDC		91.5%@72VDC		91.5%@96VDC	
Battery Mode(Full load)		89.5%@24VDC		92.5%@48VDC		92.5%@72VDC	
Charger							
Battery Type		Lead Acid Battery					
Battery Number		7Ah x 2	3	7Ah x 4/6	6	7Ah x 6/8	8
Battery Current		1K-3K : 1.0(default), 1-2A(adjustable) 1KS-3KS(External battery) : 5.0(default), 1-12A(adjustable)					
Charging Mode		Two-step charging/Three-step charging					
Circumstance Parameter							
Working circumstance Temperature		0~40°C					
Working circumstance humidity		20%~95%(No condensation)					
Storage Temperature		-15~60°C(BAT : 0~40°C)					
Altitude		Altitude should be less than 1000m, above 1000m, Reduced Amount, 4000m most, Refer to IEC62040					
Noise		<45dB(A)					

Terminal	
Terminal Type	Rs232, expandability SNMP card/USB/Dry contact card/EPO/ MBS(Maintenance bypass)
Certificate standard	
EN/IEC 61000, EN/IEC 62040.GB/T 7260.GB/T 4943.YD/T1095, TLC, etc	

Model		6K	6KS	10K	10KS
Capacity	1.0	6KVA/6KW		10KVA/10KW	
AC Input					
Input Wiring	L+N+PE				
Nominated Input Voltage	208/220/230/240VAC				
Voltage Range	110~300VAC · 110~176VAC · 280~300VAC				
Frequency Range	50/60±HZ · ±10HZ(settable)				
Power Factor	≥0.99				
Harmonic distortion	≤3%THD (Linear load) ≤5%THD (Nonlinear load) (PF=0.7)				
AC output					
Output Wiring	L+N+PE				
Voltage	110/115/120VAC				
	208/220/230/240VAC				
Precision	±1%				
Frequency	Online mode: follow the mains frequency, battery mode:50/60Hz±0.1%				
Harmonic distortion	≤2%THD (Linear load) ≤5%THD (Nonlinear load) (PF=0.7)				
Power Factor	0.9/1				
Transfer Time	0ms · ECO mode to battery mode 2ms				
Over Load	Utility Mode		Battery Mode		
	30min@102%~110%Load		1min@102%~110%Load		
	10min@110%~130%Load		10s@110%~130%Load		
	30s@130%~150%Load		3s@130%~150%Load		
	200ms@>150%Load		200ms@>150%Load		
UPS Efficiency					
Utility Mode(Full load)	The highest efficiency is 95.5%, and the full load efficiency is 95%				
Battery Mode(Full load)	Maximum efficiency 95.3%, full load efficiency 94.8% (20 batteries)				
Charger					
Battery Type Lead Acid Battery					
The number of battery	16/18/20PCS is adjustable, the default is 16PCS (refer to 4.4 for specific hardware settings) if power factor is 0.9 , the inbuilt battery numbers are : 6KVA : 12 pcs , 10KVA : 14 pcs .				
Charing Mode	1~12A adjustable the standard machine defaults to 1A charging				
Battery charge current	Two-step charging/Three-step charging				

Circumstance Parameter	
Working circumstance Temperature	0~40°C
Working circumstance humidity	20%~95%(No condensation)
Storage Temperature	-15~60°C (BAT : 0~40°C)
Altitude	Altitude should be less than 1000m, above 1000m, Reduced Amount, 4000m most, Refer to IEC62040
Noise	<45dB(A)
Terminal	
Terminal Type	RS232, expandability SNMP card/USB/Dry contact card/EPO/MBS(Maintenance bypass)
Certificate standard	
EN/IEC 61000, EN/IEC 62040.GB/T 7260.GB/T 4943.YD/T1095,TLC, etc	

Load = rated power x reduction factor at high altitude (corresponding to altitude)

Altitude (m)	1000	1500	2000	2500	3000	3500	4000
Reduction factor	100%	95%	91%	86%	82%	78%	74%



If the customer uses above 1000 m above sea level, must use the decline rating output, the reduction coefficient see the above table.

2. installation



Danger: in order to ensure safety, please pay attention to cutting off the power distribution switch before installation, if it is a long delay model, you should also disconnect the battery input.



Note :1. The following wiring must be performed by professionals in accordance with local regulations.
2. suggest to use in the way of landing installation.

2. 1 Unpacking and inspection

1) Unpack the packaging and check the package contents. The shipping package contains:

- UPS
- User manual
- Communication cable

2) Inspect the appearance of the UPS to see if there is any damage during transportation.

Do not turn on the unit and notify the carrier and dealer immediately if there is any any damage or lacking of some parts.

3) 2 Input and output power cords and protective earth ground installation

2.2 Notes for installation

1) The UPS must be installed in a location with good ventilation far away from water. inflammable gas and corrosive agents.

2) Ensure the air vents on the front and rear of the UPS are not blocked. Allow at least 0. 5m of space on each side.

3) Condensation to water may occur if the UPS is unpacked in a very low temperature environment. In this case it is necessary to wait until the UPS is fully dried inside out before proceeding installation and use. Otherwise there are hazards of electric shock.

2.3 Installation

Installation and wiring must be performed in accordance with the local electric code and the following instructions by professional personnel.

For safety, please cut off the mains power switch before installation. The battery breaker also needs to be cut off if it is a long backup time model("S"model)

1) Open the terminal block cover located on the rear panel of the UPS (please refers to the appearance diagram)

2) For 6K(S) UPS, it is recommended to select the UL1015 10AWG(6mm²) wire or the other insulated wire which complies with AWG Standard for the UPS input and output wirings.

3) For 10K(S) UPS, it is recommended to select the UI1015 8AWG (10mm²) wire or the other insulated wire which complies with AWG Standard for the UPS input and output wirings.

Note: Do not use the wall receptacle as the input power source for the UPS, as its rated current is less than the UPS's maximum input current. Otherwise the receptacle may be burned and destroyed.

4) Connect the input and output wires to the corresponding input and output terminals according to the following diagram.

Note: you must make sure that the input and output wires and the input and output terminals are connected tightly.

5) For 6K(S) UPS, please connect the input protective earth terminal to the safe position and connect the output protective earth terminal to the position protected by the load with the green and yellow wire UL 1015 10AWG(6mm²)

6) For 10K(S) UPS, please connect the input protective earth terminal to the safe position and connect the output protective earth terminal to the position protected by the load with the green and yellow wire UL 1015 8AWG(10mm²)

7) The protective earth ground wire refers to the wire connection between the equipment which consumes electric equipment and the ground wire. The wire diameter of protective earth ground wire should be at least as above mentioned for each model and green wire or green wire with yellow ribbon wire is used.

8) After having completed the installation, make sure the wiring is correct.

9) Please install the leak current protective breaker at the output power distribution panel of the UPS if necessary.

10) To connect the load with the UPS, please turn off all the loads first, then perform the connection and finally turn on the loads one by one.

11) No matter the UPS is connected to the utility power or not, the output of the UPS may have electricity. The parts inside the unit may still have hazardous voltage after turning off the UPS. To make the UPS have no output, power off the UPS, and then disconnect the utility power supply.

12) Suggest charging the batteries for 8 hours before use. After connection, turn the bypass breaker in the "ON" position, the UPS will charge the batteries automatically. Do not charge, you can also use the UPS immediately without charging the batteries first, but the backup time may be less than the standard value.

13) It is necessary to connect the inductance load such as a monitor or a laser printer to the UPS, the start-up power should be used for calculating the capacity of the UPS, as its start-up power consumption is too big when it is started.

⊕ → **Ground (yellow-green)**
L → **LINE (brown or black)**
N → **Neutral (blue)**

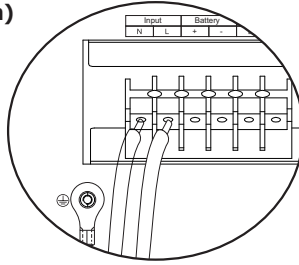

AC Input

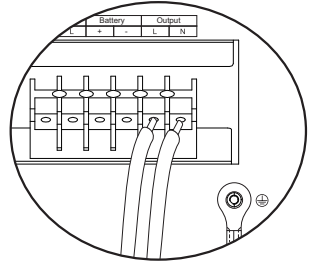

AC Output

2.4. Wiring table



Note: The straight length of the cable and the cross-sectional area of the three wires depend on the UPS rated power.

Model		6K	6KS	10K	10KS
Input	N	10AWG(6mm ²)	10AWG(6mm ²)	8AWG(6mm ²)	8AWG(6mm ²)
	L	10AWG(6mm ²)	10AWG(6mm ²)	8AWG(6mm ²)	8AWG(6mm ²)
Battery	+	10AWG(6mm ²)	10AWG(6mm ²)	8AWG(6mm ²)	8AWG(6mm ²)
	-	10AWG(6mm ²)	10AWG(6mm ²)	8AWG(6mm ²)	8AWG(6mm ²)
Output	L	10AWG(6mm ²)	10AWG(6mm ²)	8AWG(6mm ²)	8AWG(6mm ²)
	N	10AWG(6mm ²)	10AWG(6mm ²)	8AWG(6mm ²)	8AWG(6mm ²)
Ground wire	G	10AWG(6mm ²)	10AWG(6mm ²)	8AWG(6mm ²)	8AWG(6mm ²)

2.5 Connection



Danger: the rated input current allowed by the power distribution switch must be greater than the UPS input current, otherwise the power switch may burn down.

1. Please refer to the wiring table to select the input and output lines
2. Open the terminal panel ① on the rear panel of the UPS.
3. Connect the wire of the output cable to the terminal output.
4. Connect the wire of the input cable to the terminal row input, need to connect the battery cable to the battery input.

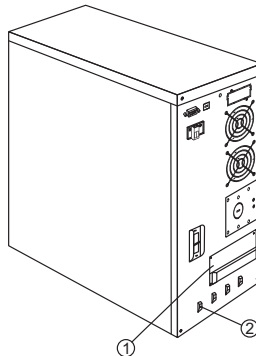

4. Tie the wire through the bundle frame ②.
5. Make binding the input, output and battery lines, adjust the wire to the appropriate position, and fix the cable.



Danger: when wiring, make sure the input and output lines and terminal row connected firmly.

Single-phase terminal row

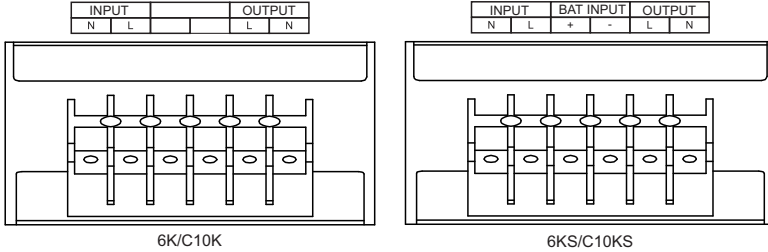

7. Reinstall the cover plate and screw the cover plate ①.
8. Connect the line, connect the electricity and put the UPS input protection switch on the ON",UPS.

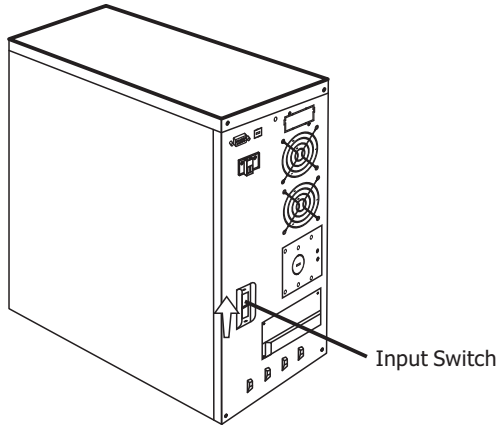

2.5 Installation of external batteries models

The DC voltage for external battery models is need to connect 16pcs of 12V lead acid battery to form a group of 192VDC, and multiple groups of batteries can be connected in parallel. However, the principle of "same voltage and same type" must be strictly observed.

The battery connection procedure is very important. If you do not follow the procedure, there may be a risk of electric shock, so please follow the steps below:

1. Set the battery switch to "OFF" and connect a suitable battery pack in series.
 2. Select the appropriate battery cable to connect the battery and UPS (refer to 2.3 wiring table).
- An air DC switch must be connected between the UPS and the battery, and the voltage and current of the switch shall not be less than the battery voltage and current specifications of the corresponding UPS model in the following table:

Model	6K(S)	10K(S)
Battery Voltage	192VDC	192VDC
Battery Current	33A.max	55.5A.max



Danger: do not connect the UPS end first, otherwise there will be a risk of electric shock.

1. Connect the other end of the battery cable to the UPS to complete the connection with the UPS battery. The UPS will not connect any load first, and then set the battery pack switch to the "ON" state, turn on the utility power, and the UPS will start charging the battery pack.

Note: The battery ground wire on the UPS is the chassis ground on the right side of the terminal block, as shown in the figure .

2.6 Connect to a computer interface

Computer interface: standard RS232 interface, connected with UPS and monitoring equipment with RS232 communication cable.

1. Connect the RS232 communication cable to the serial port of the computer.
2. Connect the RS232 communication cable to the serial port of the UPS computer.

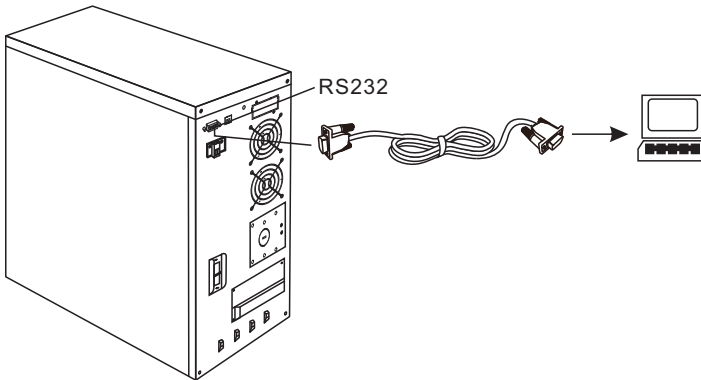

UPS computer interface foot diagram is as follows:

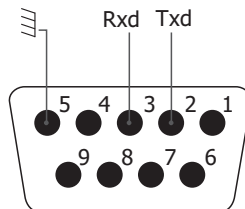

2.7 Smart card installation

The smart card is installed in the smart slot on the back cover of the machine. There is no need to stop the UPS during the process of installing the smart card:

1. First remove the cover on the smart slot.

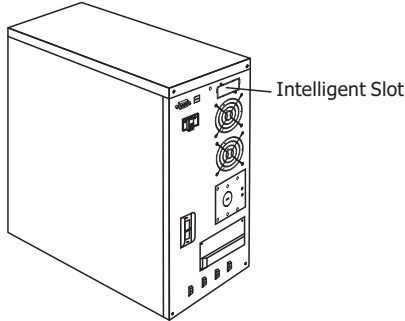

2. Insert a intelligent card (SNMP) in the slot.

3. Use screws to lock the intelligent card (SNMP)tightly.

• SNMP card (optional)

The intelligent slot on the back panel of the machine provides data allowed by SNMP.

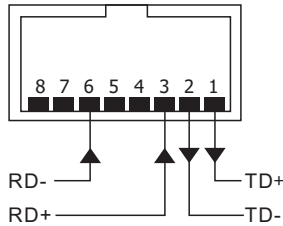

• AS400 card (optional)

Only need to install AS400 card (optional) in the intelligent card slot, you can realize the use of AS400 system monitoring function, as the monitoring management. The pin description is as follows:

Remark:

1. When PIN5 is not on, means UPS is working.

2. When PIN8 is not on, means UPS working Bypass.

Pin:	Meaning :
PIN1	Conduction : UPS failure
PIN2	Conduction : warning sound
PIN3	Ground :
PIN4	Remote shutdown:
PIN5	Common terminal does not conduct : UPS works:
PIN6	Conduction : Bypass action
PIN7	Conduction : Low Battery Voltage
PIN8	Conduction : UPS works , does not conduct , bypass works .:
PIN9	Conduction : Mains power failure

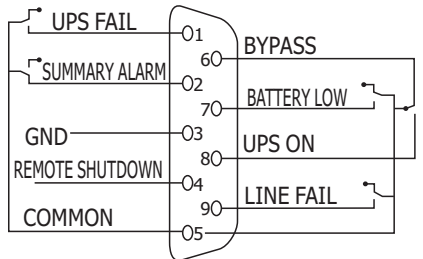

2.8 EPO Optional

The EPO (Emergency Power Off) is located in the back panel of the UPS and is a green terminal. The EPO can turn off the UPS power supply and turn off the UPS in the emergency condition.

The Specific use:

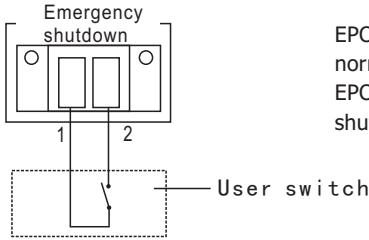

EPO interface is in the connection state UPS working normally.

EPO interface is disconnected, UPS perform emergency shutdown and display 23 alarm.

2.9 Maintenance switches(6KVA-10KVA)

Maintenance switch to achieve UPS online maintenance.

The main part of the UPS is charged, whether it is electricity, battery, bypass mode, and the UPS and electricity can be isolated by maintenance switch, and the safety of on-line repair of the UPS is guaranteed.

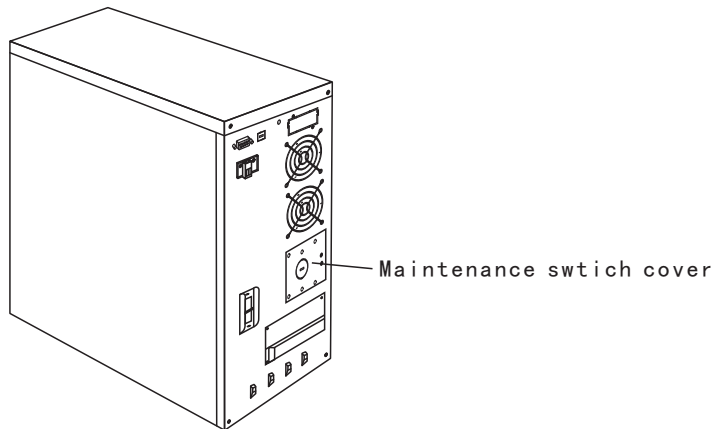
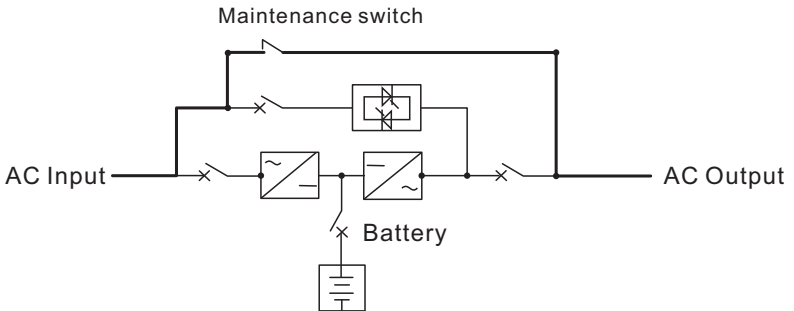

3. panel operation instructions

3.1 Panel Description

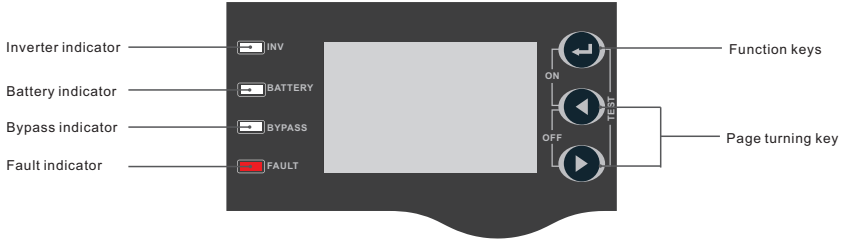

3.2 Key function

Press button	Function Description
Boot combined key (↵ + ◀)	Boot: press the boot combination key more than 0.1seconds to boot.
Shutdown Combined Key (◀ + ▶)	Shutdown: press the shutdown key more than 0.1 seconds to shut down.
Self-test/mute Key combination (↵ + ▶)	Self-test: press self-test assembly key for more than 1 second in power mode to test whether the battery is normal. Mute: Removed by pressing Mute Combinator for more than 1 second in battery/fault/check mode Alarm sound, press mute combination key again more than 1 second to restore alarm sound.
Function settings /Enter key (↵)	Unction settings: in the display page press the function settings key for more than 2 seconds to enter the function settings page, determine the options to set again press the function settings key for more than 2 seconds to return to the main display page. Enter Key: on the function settings page, press the Enter key 0.1 seconds to 2 seconds to determine set the options.
Page turning/ Query key (◀ , ▶)	Page turning: press any page (◀) or (▶) key more than 0.1 seconds to perform left or right page turning. Polling mode: press the (▶) key on the display page for more than 2 seconds to enter polling mode, Cycle display each page content, each page content display time is 2 seconds, press the (▶) key again more than 2 seconds to exit polling mode.

3.3 LED indicator functions

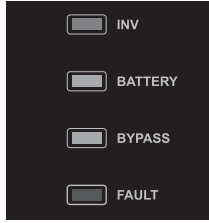

Indicator Lamp	name	Description
INV	Inverter lamp (Green)	On: UPS is working in inverter-on mode (such as: Utility mode, battery mode, battery self-test mode, ECO mode) Off: UPS is working in non-inverter mode
BATTERY	Battery Lamp (Yellow)	On: UPS is working in battery/battery self-test mode Off: UPS is working in non-battery mode and non-battery self-test mode Flashing: low battery warning
BYPASS	Bypass Lamp (Yellow)	On: UPS is working in bypass mode or ECO mode Off: UPS is working in non-bypass mode and non-ECO mode Flashing: UPS is working in standby mode, frequency conversion is not turned on and bypass is abnormal
FAULT	Warning Lamp (Red)	On: UPS failure Off: UPS is normal Flashing: UPS alarm

3.4 LCD function display:

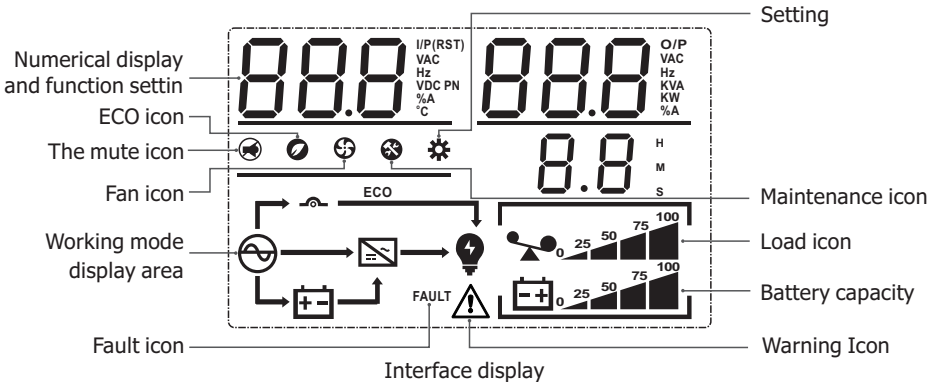

LCD display can be divided into: icon display, numerical display and function setting area, work mode display area.

- The load and battery graphics indicate the load and battery capacity. Each square represents 25% of the capacity. The load icon will flash when the UPS is overloaded.
- The battery icon flash when the battery capacity is too low or not connected.
- The fan icon shows the working status of the fan. Normally, the fan icon will light up; when the fan alarms, the icon flash.

- The buzzer icon shows whether the buzzer muted or not. Under normal circumstances, the icon not displayed; press the mute key combination(◀+▶) in battery and fault mode or set MUTE ON in software any mode, UPS enters the mute state. The buzzer icon will be displayed.
- When the maintenance switch is turned on, icon light up, In other cases, the icon is not displayed. When the ECO function is enabled, icon light up, In other cases, the icon is not displayed. When entering the setting menu, icon light up, In other cases, the icon is not displayed. The fault icon only displayed in fault mode.

Numerical display and function setting area:

Non-function setting mode, this area displays UPS related info; In normal mode, it displays output info, when you do left and right bottom (◀ or ▶) setting it will show input voltage and frequency, output voltage and frequency, battery voltage and capacity, battery cell number, load, internal temperature, software version and other related information . The failure mode displays the failure code.

Function setting page, bottom setting output voltage (OPU), expert mode (EP), low batteries Shutdown point (EOd), battery cells (PCS), emergency shutdown. (EPO)

Work Mode Display Area:

- This display area mainly displays the mode of UPS work after boot 3s. For example: standby mode, bypass mode, electricity mode, battery mode, battery self-test mode, fault mode, ECO mode.

3.5 UPS working status table for indicator light

Buzzer alarm	description
Changming	Failure mode
Chirp once a second	Battery mode lower voltage
Beep every two minutes	overload
	Convert off
Chirp once in four second	others

NUM	Mode	Light display				Sounds
		Working	Battery	Bypass	Malfunction	
1	Convert mode/VFD mode					
	No alarm	•				none
	alarm	•			★	hirp once in four second
2	Battery mode					
	None	•	•		★	hirp once in four second
	Low voltage alarm	•	★		★	Chirp once a second
3	Self detect mode/ On working mode	★	★	★	★	hirp once in four second
4	Bypass mode					
	No fault alarm			•		One beep every 2 min
	alarm			•	★	hirp once in four second
5	Economic operation mode					
	No fault alarm			•		none
	Alarm	•		•	★	hirp once in four second
6	Failure mode				•	Long beep

• The indicator light is on

★ Light flashes

3.6 Daily on and off

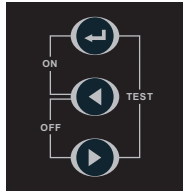

3.6.1 Turn on step

When the battery or utility power meets the requirements, it can be turned on.

Utility turn on

Access to normal utility, LCD panel display standby mode or bypass mode, press the combination key (←+◀) For more than 0.1 seconds, the LED lights are lit and extinguished in turn. After waiting for a period of time, the panel shows that the power-on mode is completed and enters the power-on mode.

Battery turn on

Access normal battery, press function settings/confirm key (↵) For more than 0.5 seconds, the display screen is lit, the panel displays standby mode, UPS the establishment of working power. Press the boot combo key (←+◀) more than 0.1 seconds to execute the boot, the LED lamp cycle in turn lit, in turn extinguished, waiting for a period of time after the panel display battery mode indicates that the boot completed, into battery mode.

3.6.2 Shutdown step

When working in power / battery / battery self-test / ECO mode, press close key (◀+▶) or more than 0.1 seconds to execute shutdown. If the bypass is normal after shutdown, the panel displays enter bypass mode; if the bypass is abnormal, the panel displays standby mode enter standby mode and disconnect output. Shutdown in bypass mode enters standby mode and breaks output.

3.6.3 Manual self-checking operation

When the UPS is in power / ECO mode and the battery voltage is greater than the low voltage alarm point, Press the self-test / mute key (←+▶) for more than 1 second and wait 10 seconds, LED lights are lit and extinguished in turn, The panel shows the battery self-test mode, Test the battery , Automatic exit after self-examination, LED and LCD restore pre-test state.

3.6.4 Mute operation

When the UPS works in battery / battery self-test / fault mode, press the self-test / mute combination key (←+▶) for more than 1 second. Press self- test / mute combination key for more than 1 second. Restore alarm sound and panel graphics display area buzzer icon disappear. the UPS can be mute / mute through the background software MUTE ON or OFF. When the UPS is in any mode,

3.6.5 Operation in alarm state

When the UPS has an alarm and LED the fault lamp flashes, the UPS works in the alarm state. Can check alarm reasons according to alarm information or contact suppliers.

3.3 LCD display :

Normally, there are eight pages in the display page. Press the query key ◀ or ▶ within 0.1 to 2 seconds to flip the display page and display information such as input, battery, output, load, software version, temperature, etc. If there is an alarm, a page of alarm information will be displayed. If the UPS fails, the fault code page will be displayed by default. The main page defaults to display fault or alarm information. When the UPS has no fault or alarm, the main page defaults to display output voltage and frequency information.

Press the right query key ▶ for more than 2 seconds, the LCD enters the polling mode display: the display page will be turned automatically every 2S, and long press ▶ again will exit the polling mode.

Display page 1 (main display page): Display UPS input and output voltage.

3.6.6 Operation in fault mode

When the UPS buzzer is long and LED the fault light is on, the UPS works in fault mode. Contact suppliers or maintenance personnel to provide fault alarm information and assist in troubleshooting.

3.7 Parameter Query Operation

Normally, the display page has eight pages, press the query key ◀ or ▶ 0.1 to 2 seconds to turn the display page, display the input, battery, output, load, software version, temperature and other information. If there is an alarm, will add a page of alarm information display, if the UPS fail, will display the fault code page by default. Failure or alarm information is displayed by default on the main page. When there is no fault or alarm in the UPS, the main page is displayed as output voltage and frequency information by default.

Press the right query key ▶ or more than 2 seconds, LCD enter polling mode display: every 2 S automatically page the display page, again long press ▶ will exit polling mode

Display page 1 (main display page): Display UPS input and output voltage, as shown in Figure 1

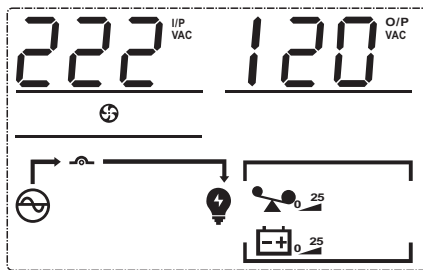

Page 1

Display page 2: Display UPS input and output frequency.

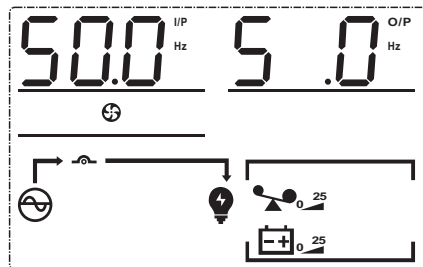

Page 2

Display page 3: Battery information, display battery voltage and battery capacity.

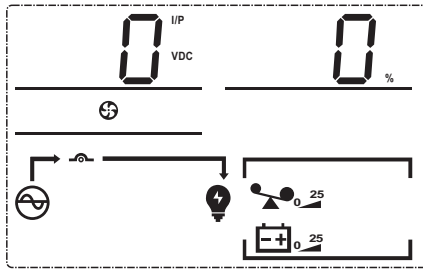

Page 3

Display page 4: Output information, display output voltage and active power.

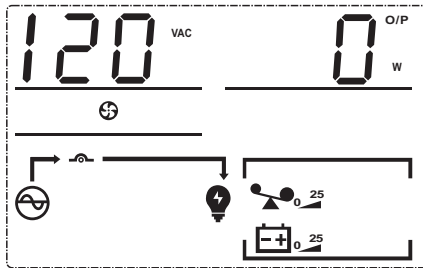

Page 4

Display page 5: Output information, display output voltage and apparent power.

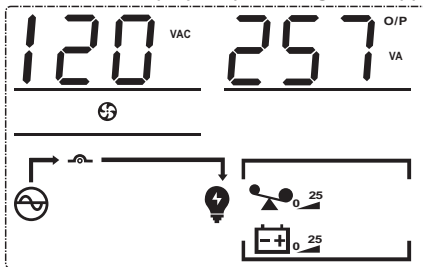

Page 5

Display page 6: Output information, display output voltage and load percentage.

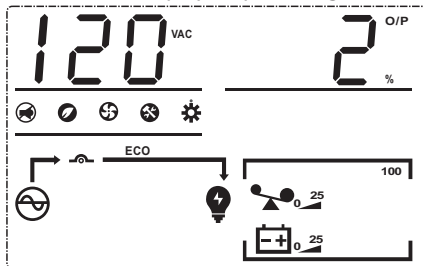

Page 6

Display page 7: Software version, display the UPS system software version. (software version VER 34)

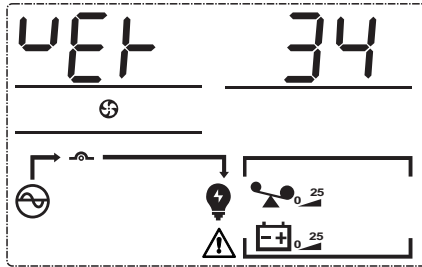

Page 7

Display page 8: battery information, displays the number of battery packs.

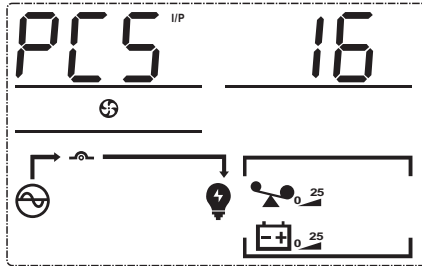

Display page 8

Alarm display page 9: Alarm information is displayed, (The icon shows battery failed to receive alarm, ALA is the abbreviation of ALARM, and the alarm icon at the bottom flashes to indicate alarm; 1 is the alarm code). Please refer to Failure and Alarm Instructions for detailed alarm information.

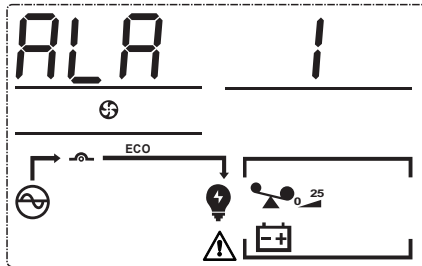

Page 9

Operation

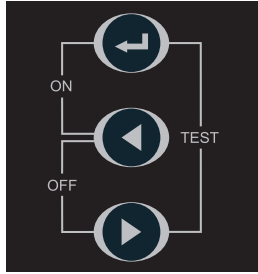

Power on/off

Please refer to this manual for switch operation

The steps to turn on

When the battery or utility power meets the requirements, it can be turned on.

Utility power-on

When the utility is connected and the LCD panel displays standby mode or bypass mode, press the power-on key combination (← + ◀) for more than 0.1 seconds to start the machine. The LED lights turn on and turn off by turn. After waiting for a period of time, the screen displays the utility mode that means the power-on is completed and enter the utility mode.

Battery power-on

access the normal battery, press the function setting/confirmation key (←) more than 0.5 seconds, the display screen lights up, the panel shows standby mode, UPS establish the working power supply. press the boot combination key (← + ◀) at this time more than 0.1 seconds to execute the boot, the LED lamp cycle is lit in turn, extinguished in turn, waiting for a period of time after the panel display battery mode indicates that the boot is completed, into battery mode.

Power-off steps

When working in power/battery/battery self-test/ ECO mode, press the shutdown unit key (◀ + ▶) for more than 0.1 seconds to perform shutdown. If the bypass is normal after shutdown operation, the panel display enters bypass mode; if the bypass is abnormal, the panel display standby mode enters standby mode and breaks output. Turn off in bypass mode and switch off the output.

Manual self-checking operation

When the UPS is in utility/ ECO mode and the battery voltage is greater than the low voltage alarm point, Press the self-check/mute combo (← + ▶) for more than 1 second and wait for 10 seconds, LED lights turn on and off in turn, The screen shows battery self-test mode, To test the battery, Automatic exit after self-examination, LED and LCD restore pre-test status.

Mute operation

when the UPS is working in battery/battery self-check/fault mode, press the self-check/mute combination key (← + ▶) for more than 1 second, the screen area displays the buzzer icon to eliminate the alarm sound at the same time, and then press the self-check/mute combination key for more than 1 second to restore the alarm sound and the screen area buzzer icon disappears. When the UPS is in any mode, you can set MUTE ON or OFF through the background software to mute/unmute the UPS .

Operation in alarm state

When the UPS has an alarm sound and the LED fault light flashes, it indicates that the UPS works in the alarm state. You can check the reason or contact the supplier according to the alarm information.

Operation in fault mode

When the UPS buzzer beeps and the LED fault light is on, it means that the UPS is working in fault mode. Please contact the supplier or the maintenance person to provide the fault alarm related information and assists in the troubleshooting.

Parameter query operation

Normally, there are eight pages in the display page. Press the query key ◀ or ▶ within 0.1 to 2 seconds to flip the display page and display information such as input, battery, output, load, software version, temperature, etc. If there is an alarm, a page of alarm information will be displayed. If the UPS fails, the fault code page will be displayed by default. The main page defaults to display fault or alarm information. When the UPS has no fault or alarm, the main page defaults to display output voltage and frequency information.

Press the right query key ▶ for more than 2 seconds, the LCD enters the polling mode display: the display page will be turned automatically every 2S, and long press ▶ again will exit the polling mode.

Function setting operation

UPS function setting operation, setting operation in standby/bypass mode.

The specific operations for entering and exiting the function setting page and function setting are as follows:

- Press the function setting button ↵ or more than 2 seconds to enter the function setting page, press the query button ◀ or ▶ about 0.1 to 2 seconds to select the function, and after turning the page to the required function setting page, the corresponding function word flashes.
- Press the confirm button ↵ for 0.1 to 2 seconds to enter the setting page of the selected function. At this time, the word of the selected function is lit, and the value of the word of the selected function flashes. Press the query key ◀ or ▶ about 0.1 to 2 seconds to select the value of the required function parameter.
- After turning the page to the function parameter you need to select, press the confirm button ↵ for 0.1 to 2 seconds, the function setting is completed, and the function parameter value is long on and no longer flashes.

Press the function setting button ↵ for more than 2 seconds to exit the function setting page and return to the main display page (you can also do nothing, and automatically jump back to the main display page after waiting for up to 30 seconds).

Output Voltage (OPU)

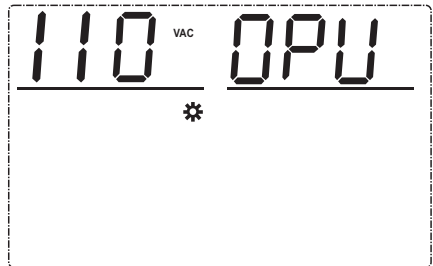
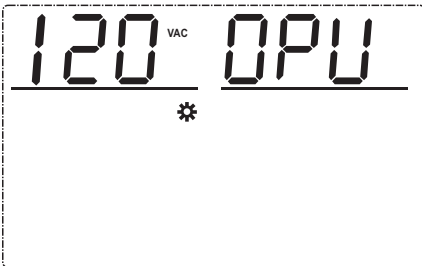

Output voltage setting page

- Press the function setting key for more than 2 seconds to enter the function setting page, press the query key ◀ or ▶ for 0.1 to 2 seconds to select the function, after turning the page to the output voltage OPU setting page, the word OPU flashes.
- Press the confirm button ↵ for 0.1 to 2 seconds to enter the output voltage OPU setting page. At this time, the word OPU is on and the value flashes to the right of the word OPU. Press the query key ◀ or ▶ for 0.1 to 2 seconds to select different output voltage values. The available voltage values are 100V, 110V, 115V, 120V, 127V. By default, the output voltage is 120V, and the settings made are saved in real time.

After turning the page to the desired output voltage value, press confirm button for 0.1 to 2 seconds, the output voltage OPU setting is completed, at this time the value on the right of OPU is on and no longer flashing.

Press the function setting key ↵ or more than 2 seconds to exit the function setting page and return to the main display page (it will automatically jump back to the main display page after waiting for up to 20 seconds).

Caution:

When the output voltage is set to be 100V, the output needs to be derated to 90%.

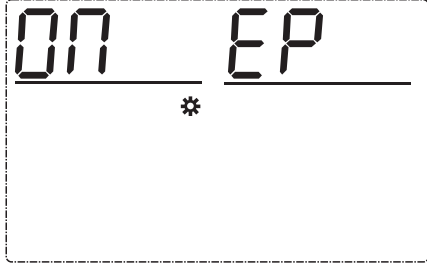
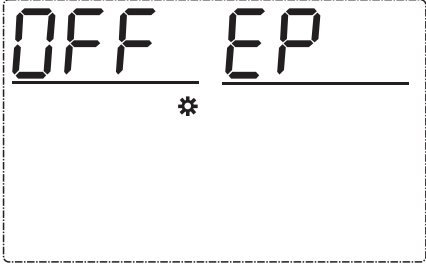

setting page in EP mode

Caution:

The EP mode is OFF by default, and the EP will return to OFF after powering on again.

Low battery shutdown point(EOD)

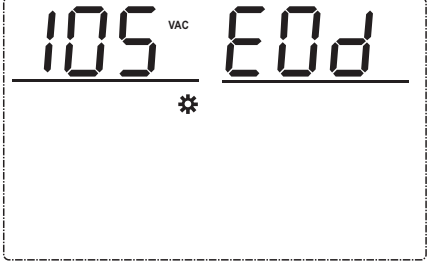
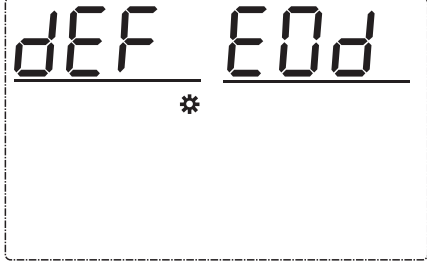

setting page in EOD

Remark:

The battery low-voltage shutdown points available selection are dEF, 9.8V, 9.9V, 10V, 10.2V, and 10.5V. By default, the battery low-voltage shutdown point is dEF (the battery low-voltage shutdown point varies with load, 10.5V@load<25%, 10.2V@25%<load<50%, 10V@load>50%).

ECO mode (ECO)

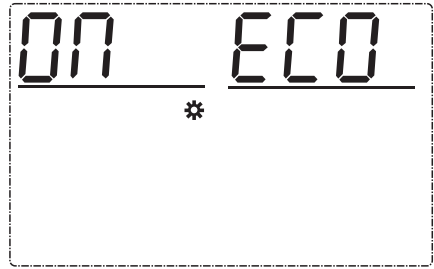
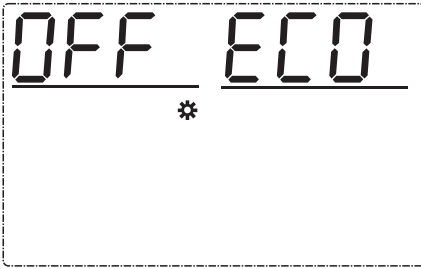

Economic Mode Settings Page

Description:

Economic mode is closed by default and can be turned on to improve system efficiency.

Note:

PF<1 of the machine, off by default, can not be set.

Emergency downtime (EPO)

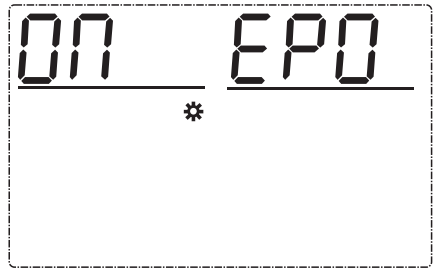
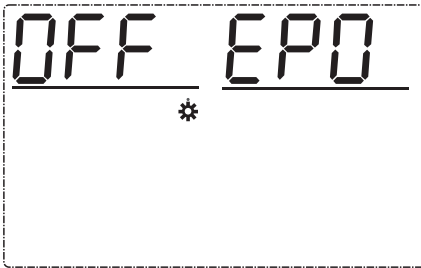

Emergency Stop Settings page

Description:

When EP is set to ON, the EPO option appears on the function setting page, and the emergency stop can be set. The emergency stop function is effective (OFF) when the EPO terminal is pulled out by default, and it can be changed to be effective (ON) when the EPO terminal is inserted.

Note:

Emergency shutdown output power down after EPO action.

The battery section number

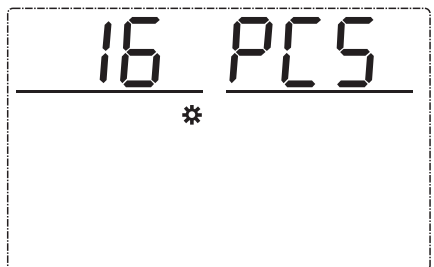

Battery number setting page

Remarks:

When EP is set to ON, the PCS option appears on the function setting page, enter the password page, and after entering the password (the general password is 135), the number of battery cells can be set. 6K/10K The battery cell number system defaults to 16 cells, and it can be set to other battery cell numbers 16/18/20.

Charging current(CHG)

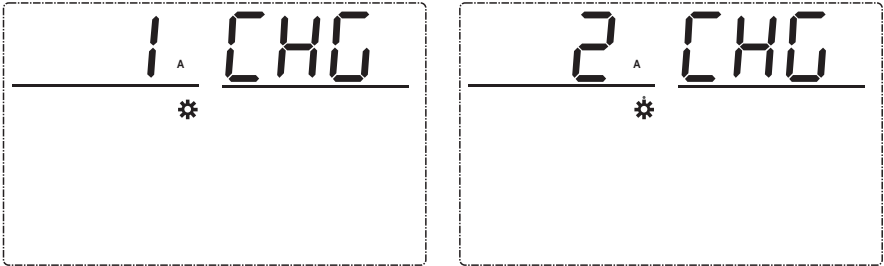

Battery number setting page

Remarks:

When EP is set to ON, the CHG option appears on the function setting page to set the charging current, 1-12A is optional, and the default is 1A;

Note:

When the UM1 command is sent to the standard machine, the charging current is 1A by default and cannot be modified.

Fault and Warning Instructions

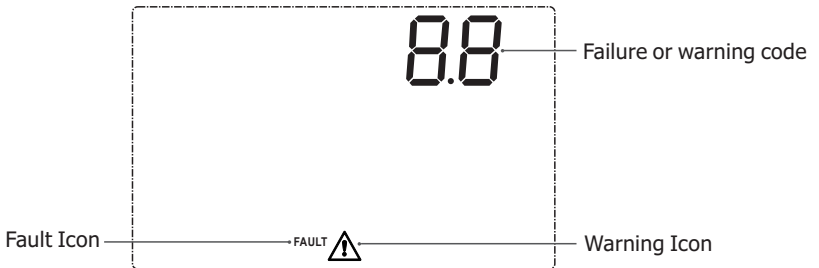

Fault and alarm LCD display as shown in the picture above, the failure mode fault icon long bright, alarm status warning icon flashing, according to the fault information contact manufacturers to eliminate abnormal conditions.

Communication Port

Intelligent slot

This series is equipped with an intelligent slot for Web power (optional accessory) to achieve remote management of the UPS through internet/intranet. Please contact your local distributor for further information.

RS232 interface

1) The following are the descriptions and pin assignment of Rs232 DB-9 port: Baud rate: 2400bps
 Data bit: 8 bit
 Ending bit: 1 bit
 Parity bit: None
 Below is DB--9 pin assignment

Pin number	Function description	I/O
3	Rx	input
2	Tx	output
5	Ground	GND

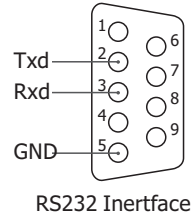

RS232 Inertface

Optional AS400 interface

This optional AS400 card provides dry contact
 Following are the pin assignment and the descriptions of AS400 card:

PIN1: UPS failure (normally open, active close)
 PIN2: summary alarm
 PIN3: ground PIN4: Remote shutdown
 PIN5: Common
 PIN6: Bypass active(relay close)
 PIN7: Battery low
 PIN8: UPS On(relay close)
 PIN9: Utility Power failure (normally open, active close)

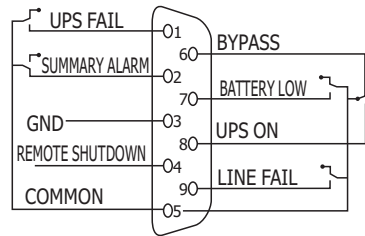

AS400 Interface

Chapter 5 Notes for battery disposal

- This series UPS only requires minimal maintenance. The battery used for standard models are regulated sealed lead-acid maintenance free battery. These models require minimal repairs. The only requirement is to charge the UPS regularly in order to maximize the expected life. When being connected to the utility power, whether the UPS is turned on or not, the UPS keeps charging the batteries and also offers the protective function of overcharging and over discharging.
- The UPS should be charged once every 4 to 6 months if it has not been used for a long time.
- In the regions of hot climates, the battery should be charged and discharged every 2 months. The standard charging time should be at least 12 hours.
- Under normal conditions, the battery life last 3 to 5 years. In case if the battery is found not in good condition earlier replacement should be made. Battery replacement should be performed by qualified personnel.
- Replace batteries with the same number and same type of batteries.
- Do not replace the battery individually. All the batteries should be replaced at the same time following the instructions of the battery supplier.
- Normally, the batteries should be charged and discharged once every 4 to 6 months. Charging should begin after the UPS shuts down automatically in the course of discharging, the standard charging time for the standard UPS should be at least 12 hours.

1) Before disposing of batteries, remove conductive jewelry such as necklace, wrist watches and rings.

- 2) If it is necessary to replace any connection cables, please purchase the original materials from the authorized distributors or service centers, So as to avoid overheat or spark resulting in fire due to insufficient capacity.
- 3) Do not dispose of batteries or battery packs in a fire, they may explode.
- 4) Do not open or mutilate batteries, released electrolyte is highly poisonous harmful to the skin and eyes.
- 5) Do not short the positive and negative of the battery electrode, otherwise, it may result in electric shock or fire.
- 6) Make sure that there is no voltage before touching the batteries. The battery circuit is not isolated from the input potential circuit. There may be hazardous voltage between the battery terminals and the ground.
- 7) Even though the input breaker is disconnected, the components inside the UPS are still connected with the batteries, and there are potential hazardous voltage. Therefore, before any maintenance and repairs work is carried out, switch off the breaker of the battery pack or disconnect the jumper wire of connecting between the batteries.
- 8) Batteries contain hazardous voltage and current Battery maintenance such as the battery replacement must be carried out by qualified personnel who are knowledgeable about batteries. No other persons should handel the batteries.

Chapter 6 Trouble shooting

Trouble shooting

Fault Instructions

Fault: UPS is in trouble mode, LED red light is always on, LCD shows fault code.

Fault Code Table

Fault code		Related Action	Trigger condition	Recovery Condition	Fault alarm
1	Bus soft start fail	Switch to fault mode	Bus soft start,30s cannot reach 380V	Unrecoverable	Fault
2	Bus high	Switch to fault mode	Bus over 450V, lasting 5s	Unrecoverable	Fault
3	Bus low	Switch to fault mode	Bus above 200V, lasting 400ms	Unrecoverable	Fault
7	Over temperature	Switch to fault mode	PFC or INV temperature sensors above 85 °C	Unrecoverable	Fault
8	Battery Relay short	Switch to fault mode	Battery voltage over 310V, lasting 4s	Unrecoverable	Fault
9	Bus soft start relay fail	Switch to fault mode	The bus relay is still below 50V after 5s soft start	Unrecoverable	Fault
10	Bus short	Switch to fault mode	When working normally, the bus is below 180V in an instant	Unrecoverable	Fault
17	INV soft start fail	Switch to fault mode	The rated output voltage cannot be reached after 40s soft starting	Unrecoverable	Fault alarm
18	INV over voltage	Switch to fault mode	The inverter voltage is above 276V,lasting 400ms	Unrecoverable	Fault
19	INV under voltage	Switch to fault mode	The inverter voltage is below 130V,lasting 400ms	Unrecoverable	Fault
20	INV short	Switch to fault mode	Inverter voltage is less than 50V,current is greater than 20A, lasting 4s	Unrecoverable	Fault
26	Negative power	Switch to fault mode	Inverter power is less than -2400W for 20ms, or -800W for 120ms	Unrecoverable	Fault
33	INV relay fail	Switch to fault mode	When the inverter relay is closed, the difference between the inverter voltage and the output voltage exceeds 30V for 160ms	Unrecoverable	Fault
34	INV relay short	Switch to fault mode	When the bypass relay is closed, the inverter relay is disconnected and the inverter bridge is not working, the difference between the inverter voltage and the bypass voltage is less than 30V	Unrecoverable	Fault

35	Bypass relay fail	Switch to fault mode	When the bypass relay is closed, the difference between the bypass voltage and the output voltage exceeds 30V for 160ms	Unrecoverable	Fault
36	Bypass relay short	Switch to fault mode	When the bypass relay is off and the inverter relay is off, the difference between the output voltage and the bypass voltage is less than 30V for 160ms	Unrecoverable	Fault
37	Wrong wiring	Switch to fault mode	The bypass relay is off. When the inverter relay is off, the bypass voltage is less than 20V, but the output voltage is greater than 150V	Unrecoverable	Fault
39	Charger short	Switch to fault mode	The battery voltage is less than 50V and the charging current is greater than 4A	Unrecoverable	Fault
66	Overload fault	Switch to fault mode	Load exceeds specifications	Unrecoverable	Fault
67	Battery reverse	Switch to fault mode	The battery input is reversed;	Unrecoverable	Fault
73	No boot loader	Switch to fault mode	No bootloader	Unrecoverable	Fault

Alarm description

Alarm: The UPS does not enter the failure mode, the red LED flashes, and the LCD displays an alarm code.

Alarm code table

Fault code		Related Action	Trigger condition	Recovery Condition	Fault alarm
1	Battery open	Alert, battery not charging	Battery voltage is lower than 8V/section	Recoverable (10V/section)	Alert
2	Battery low	Alarm, battery test mode will return to mains mode	10.5~14V/section(2) Default 11.2V/section Custom settings: 10.5~14V/section(2)	Recoverable (operating point +0.2V/section)	Alert
8	Battery high	Recharge	When the battery is set to custom, the overvoltage point is constant voltage charging voltage +0.4V/cell	When the battery is set to custom, the recovery point is constant voltage charging voltage -0.4V/cell)	Alert
9	Charger fail	Alert	After 5 minutes of charging, the battery voltage is still less than 10V	Recoverable (battery voltage>10.5V)	Alert
10	Over temperature warning	Alert, battery not charging	PFC or INV temperature sensor is higher than 80°C	Recoverable (temperature sensor below 75°C)	Alert
12	Fan lock	Alert	No fan speed signal detected	Recoverable	Alert
13	Line fuse open	Alert	The difference between the mains voltage and the bypass voltage is greater than 100V	Recoverable	Alert
14	EEPROM fail	Alert	EEPROM read and write failed	Unrecoverable	Alert
21	Overload warning	Alert, battery not charging	Alert, battery not charging	Recoverable (load <97%)	Alert
23	EPO active	Alert, battery not charging		Recoverable	Alert
24	MBS active	Alert	Short circuit of CN4 terminal on control board	Recoverable	Alert

